

T S S C

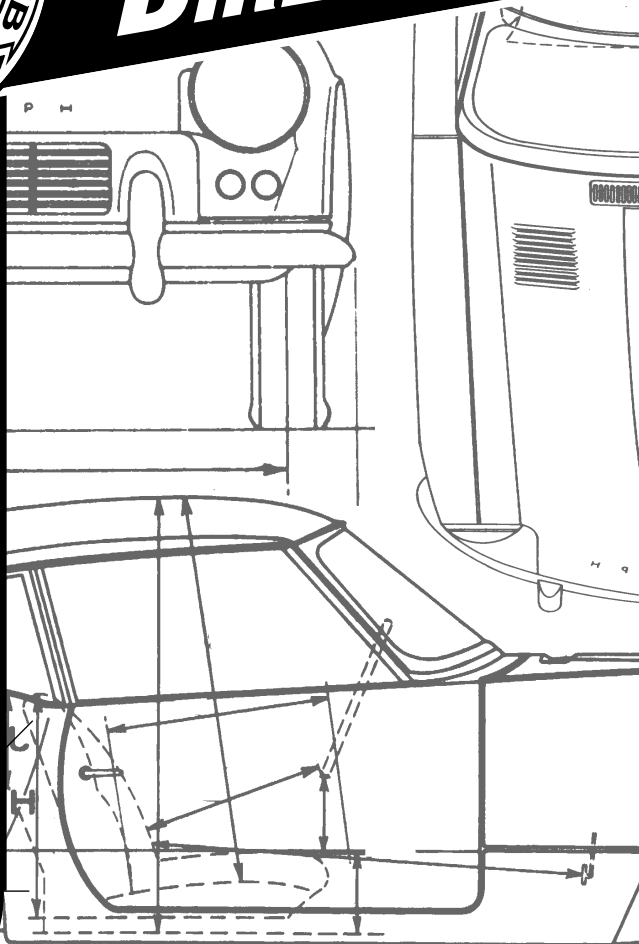

TECHNICAL DIRECTORY

- AMPHICAR
- BOND
- COMPETITION
- COP SHOP RULES
& REGULATIONS
- GT6
- HERALD
- SPECIALS
- SPITFIRE
- STAG
- TOLEDO / DOLOMITE
1300/1500
- TR
- 2000/2500/2.5PI
- VITESSE
- TECHNICAL - ALL
- TECHNICAL
SPECIFICATIONS

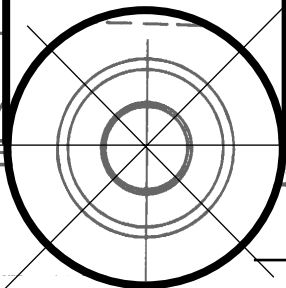

Compiled by Peter Williams

AMPHICAR BOND GT6 HERALD SPECIALS SPITFIRE STAG TOLEDO/DOLOMITE 1300/1500 TR 2000/2500/2.5PI VITESSE

July 1980 to November 2005 The Courier Numbers 1-305, and Turning Circles 1-16

Technical Directory

Introduction

Welcome to the 2006 edition of the Triumph Sports Six Club Technical Directory. What this is, is as full a listing as we can manage of all technical articles, tips, buying guides and profiles that have been published within TSSC publications since July 1980 up to November 2005, covering both 'The Courier' and 'Turning Circle' magazines. Articles are principally listed by car model and technical topic subsections.

A separate, wide ranging Technical section serves to cover references to non model specific articles and also as a cross reference to model specific articles.

Topics include: Bodywork / Chassis, Brakes, Carburettors, Car Profiles / Buying, Cooling System, Electrical, Engine/Ancillaries, Exhaust Systems, General / Miscellaneous, Mechanicals (Other), Paint, Restoration / Rebuild Projects, Suspension/Steering, Transmission, Trim, Wheels and Tyres and Workshop Techniques.

Information relating to individual models are indexed within their own sections or, as appropriate for more

general technical requirements common to other vehicles, through the Technical and other models' sections. The latter approach applies to Specials too but these vehicles are also covered by 'Specials Listing', 'Construction' and other 'General Tips' categories. As may be imagined, there are fewer topics covered for some models either due to their rarity (e.g. Amphicar) or those for which we are currently in the process of building up technical articles for. Legal and regulatory issues are also covered under 'Cop Shop, Rules and Regulations'. Last but not least, a separate section towards the rear of the Directory contains listings of selected technical specifications across the range.

So, to find any particular technical topic try looking in the section on your car but then follow this up into the overall 'Technical' section. You can then refer to your Courier/Turning Circle collection to find the articles you're looking for. Remember also that if not in your possession, many of the magazine issues are still available through the Club's back issue service. We trust that you will find this Directory useful and of course constructive comments are very welcome for when the time comes to update this issue

Happy Motoring.

**Peter Williams, Editor,
TSSC Technical Directory.**

Index

<u>ITEM</u>	<u>PAGE No.</u>
<i>Amphicar</i>	4
<i>Bond Equipe</i>	4
<i>Competition</i>	5
<i>Cop Shop Rules and Regulations</i>	6
<i>GT6</i>	9
<i>Herald</i>	11
<i>Specials</i>	15
<i>Spitfire</i>	17
<i>Stag</i>	22
<i>Toledo/Dolomite 1300/1500</i>	23
<i>TR</i>	23
<i>2000/2500/2.5PI</i>	23
<i>Vitesse</i>	23
<i>Technical - all models</i>	27
<u>TECHNICAL SPECIFICATIONS:</u>	40
<i>Herald/Vitesse</i>	41
<i>Spitfire</i>	42
<i>GT6</i>	43
<i>Stag</i>	43
<i>Toledo/Dolomite 1300/1500</i>	44
<i>TR</i>	45
<i>2000/2500/2.5PI</i>	47

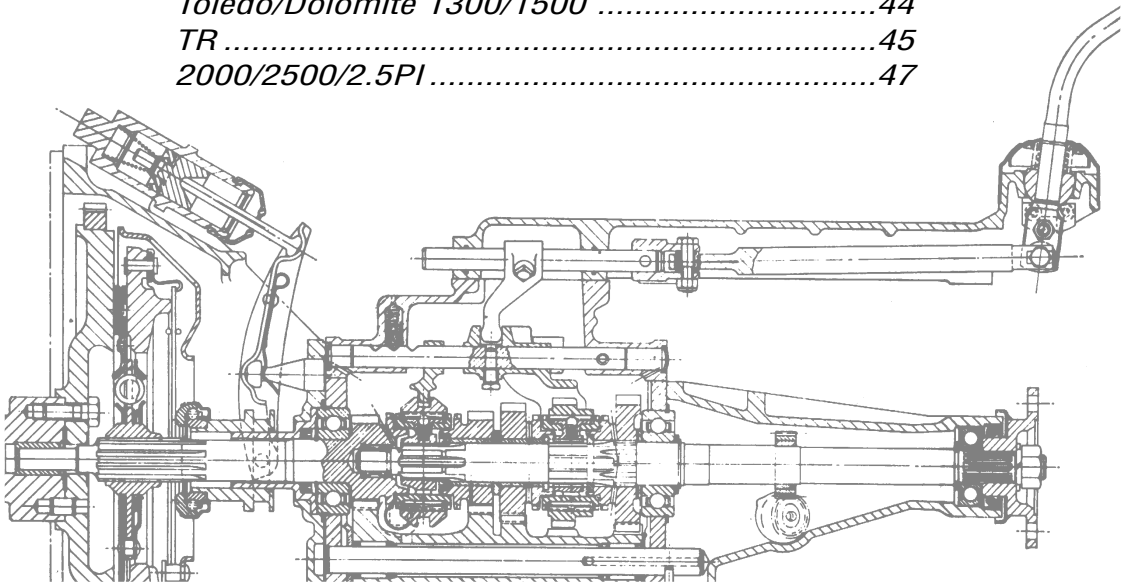

Bond Continued



<u>Item</u>	<u>Page & Issue No.</u>	<u>Item</u>	<u>Page & Issue No.</u>
Production Changes	p60 Sep 02 No.267 p15 Sep 99 No.231, p22 Oct 99 No.232, p18 Nov 99 No.233	2-Litre	p26 Feb 93 No.152 p47 Aug 00 No.242
Production Details	p22 July 99 No.229, p61 Jan 00 No.235	2-Litre Replacement Parts	p23 Mar 04 No.285
Product Development Committee Mins.	p47 Apr 00 No.238, p38 Jun 00 No.240, p33 July 00 No.241, p50 Aug 00 No.242, p40 Sep 00 No.243, p11 Nov 00 No.245, p35 Dec 00 No.246, p40 Jan 01 No.247, p59 Mar 01 No.249, p25 Apr 01 No.250, p25 Jun 01 No.252, p60 Jul 01 No.253, p62 Sep 01 No.255, p70 Nov 0 No.257, p70 Dec 01 No.258, p67 Jan 02 No.259, p62 Feb 02 No.260, p31 May 02No.263, p38 Jun 02 No.264, p35 Oct 02 No.268, p68 May 03No.275, p44 Aug 03 No.278, p57 Sep 03 No.279, p20 Apr 04 No.286, p38 May 04No.287, p40 Feb 05 No.296, p26 Apr 05 No.298, p62 May 05 No.299	2+2s 2+2 Parts Sources Windscreen Seals (2-Litre)	p48 Dec 02 No.270 p63 Jan 04 No.283 p62 Jan 04 No.283 4
Rear Screen Rubber Seal	p63 Oct 01 No.256, p68 Nov 01 No.257	Mechanicals (Other): Parts Interchangeability Towbar Fitting	p21 Nov 83 No.41 p26 Aug 02 No.266
Register Update	p62 Jul 03 No.277	Restoration/Rebuild Projects: Early Bond Rebuild Estate Build GT 2+2 Restoration Rally Car Rebuild Equipe Restorations Sexie (GT4S)	p25 Jun 91 No.132 p14 Dec 98 No.222 p42 Feb 95 No.176 p23 Nov 84 No.53 p22 Jan 05 No.295 p39 Mar 02 No.261, p15 Apr 02 No.262 p31 Jun 95 No.180 p18 Feb 00 No.236
Serial Numbers	p34 Dec 84 No.54,	Suspension and Steering: Steering Kickback Note Steering Wheels	p47 Aug 00 No.242 p40 Jan 03 No.271
		Trim: Aftermarket Consoles Bits and Pieces (Tonneau) Body Colours Bonnet Trims Trim Clips 2-Litre Convertible Hood 2+2 Rear Window Seals	p8 Sep 97 No.207 p20 Nov 87 No.89 p56 Mar 01 No.249 p34 Nov 04 No.293 p20 Mar 96 No.189 p28 Oct 95 No.184 p46 Apr 00 No.238
		Workshop Techniques: GRP Repairs Fibreglass Repairs Metal in Fibreglass Repairs Paint Removal	p15 Oct 93 No.160 p10 Nov 95 No.185, p29 Aug 94 No.170 p23 Jan 96 No.187 p27 Dec 92 No.150

Competition



<u>Item</u>	<u>Page & Issue No.</u>	<u>Item</u>	<u>Page & Issue No.</u>
Car Preparation for Racing	p40 Jan 04 No.283	Marshal for the Day	p48 May 03 No.275 p42 Feb 05 No.296
Concours Spitfire / Autoglym 588 SHY	p51 Oct 01 No.256, p24 Nov 01No.257, p60 Jan 02 No.259	Mugello Spitfires	p68 Sep 05 No.303
Concours Tips/Rules/Classes	p34 Jul 04 No.289, p34 Mar 05 No.297, p20 Apr 05 No.298, p20 Jun 05 No.300, p44 Jul 05 No.301	Racecar Preparation?	p40 Apr 02 No.262
Concours Car Preparation	p55 May 05 No.299	Racing GT6	p28 Oct 00 No.244
Concours to Trackday	p70 Feb 05 No.296	Racing GT6 (Peter Cox's)	p53 May 01 No.251
GT6 Project	p62 Jan 03 No.271, p48 Feb 03 No.272, p56 Apr 03 No.274,	Rally Bond	p44 Nov 05 No.305
		Road Car or Race Car? Tigger	p68 Jul 05 No.301, p32 Oct 05 No.304
		Scruiteneering	p74 Oct 03 No.280
		Silver Bullet	p52 Aug 00 No.242, p60 Aug 04 No.290
		Superweight GT6	p18 Feb 01 No. 248



Cop Shop Rules & Regulations

Item	Page & Issue No.	Item	Page & Issue No.
Abandoned Vehicles	p6 Dec 84 No.54, p11 Apr 88 No.94		p19 Dec 88 No.102, p9 Dec 90 No.126,
Accident Law/Procedure	p8 Nov 84 No.53, p10 Nov 85 No.65, p9 Jan 89 No.103, p10 Aug 90 No.122, p8 Feb 93 No.152, p9 Mar 95 No.177, p7 Sept 98 No.219, p8 July 00 No.241, p11 Oct 03 No.280		p9 Jul 95 No.181, p8 Dec 96 No.198, p24 Dec 01 No.258 p11 Jul 90 No.121
Adverse Weather Driving	p8 Jan 05 No.295, p8 Nov 05 No.305	Driving in Holland	p11 Jun 90 No.120, p20 Feb 91 No.128, p9 Apr 96 No.190, p7 May 96 No.191, p9 Sep 00 No.243
April 1st Route Designations	p10 Apr 02 No.262	Driving Licences	p14 Dec 91 No.138
Audible Warning Instruments	p11 Sep 03 No.279, p10 Apr 04 No.286	Drug Testing on Drivers	p8 May 05 No.299
Belt Up!	p8 Mar 98 No.213, p7 Apr 98 No.214	Drunk in Charge of a Motor Vehicle	p6 Oct 84 No.52
Brakes	p11 Sep 88 No.99, p8 Apr 90 No.118, p11 Dec 92 No.150, p15 Mar 93 No.153, p9 Jun 94 No.168, p9 Apr 97 No.202	DVLA Searches	p70 May 01 No.251
Broken Down Vehicles	p11 Oct 88 No.100, p9 Apr 92 No.142, p12 Feb 94 No.164, p9 Apr 95 No.178	DVLA Updates	p18 Feb 99 No.224
Buying a Second-hand Car	p14 Feb 90 No.116	Endorsements	p6 Dec 84 No.54, p11 Apr 88 No.94
Buying a Stolen Car	p6 Dec 84 No.54, p11 Apr 88 No.94	Events Organising	p20 Mar 02 No.261
Child/Baby Seats	p11 Sep 94 No.171, p9 Oct 94 No.172, p9 Jan 9, p7 Apr 98 No.214, p11 Oct 02 No.268, p10 Nov 02 No.269	Exhaust Emmissions	p19 Jun 91 No.132, p15 Dec 91 No.138, p8 Sep 93 No.159, p8 Aug 96 No.194
Clocking	p4 Jul 86 No.73	Females Alone	p19 Feb 92 No.140, p9 Feb 95 No.176
Competition Driver Registration Scheme	p11 Jul 92 No.145	Fitness to Drive	p8 Oct 85 No.64, p11 Nov 90 No.125, p9 May 93 No.155, p9 Jul 95 No.181, p20 Dec 97 No.210, p26 July 99 No.229, p9 Mar 01 No.249, p12 Dec 04 No.294
Compulsory Insurance	p9 Aug 00 No.242	Fixed Penalty Notices	p9 Jan 87 No.79, p11 Jun 90 No.120
Construction and Use Regulations	p9 Apr 97 No.202, p9 May 01 No.251, p7 Aug01 No.254, p11 03 No.275, p11 May 04 No.287	Fog Code	p15 Dec 85 No.66
Convoys	p12 Aug 86 No.86, p18 Aug 91 No.134, p9 Jul 94 No.169, p10 May 02 No.263, p10 Jun 02 No.264	Fog Lights Regulations	p5 Jul 80 No.1, p9 Nov 95 No.185, p65 Jan 95 No.175, p8 Jan 97 No.199
Convoy Etiquette/Organising	p70 May 99 No.227, p70 Jun 99 No.228, p8 May 00 No.239, p8 Jun 00 No.240	Foot and Mouth	p10 Jun 01 No.252
Customising	p8 Jan 85 No.55, p11 Apr 88 No.94	Fraud Warnings	p66 Aug 04 No.290, p70 Sep 04 No.291, p70 Oct 04 No.292
Data Protection Act	p12 May 88 No.95	French Registrations	p64 May 05 No.299
Drinking and Driving	p19 Mar 86 No.69, p16 Dec 87 No.90,	GB plates	p7 Sep 97 No.207
		Gopeds	p11 Mar 03 No.273
		Green Cross Code	p20 Feb 91 No.128
		Hillclimbing and Sprinting Requirements	p75 Jul 97 No.205
		Horns	p8 Sep 85 No.63, p10 Sep 90 No.123, p11 Dec 92 No.150, p9 Jul 96 No.193
		Incorrectly Registered Vehicles	p9 Oct 05 No.304
		Institute of Advanced Drivers	p10 Nov 86 No.77, p10 Mar 89 No.105, p20 Jul 91 No.133, p9 Jul 93 No.157,

Cop Shop Rules & Regulations Continued

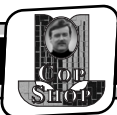

Item	Page & Issue No.	Item	Page & Issue No.
.....	p7 Jun 96 No.192,	Police and Criminal Evidence Act	p5 May 86 No.71
.....	p10 Aug 02 No.266	Police Stopping Procedure	p12 May 88 No.95
Insurance cover	p7 Sep 97 No.207	Production of Documents	p10 Nov 85 No.65
Lighting	p10 Jun 86 No.72,	Prohibitions	p11 Apr 93 No.154
.....	p9 Feb 87 No.80,	Radio and Tyres Regulations	p11 Jul 04 No.289
.....	p11 Jan 90 No.115,	Rear seats in a Spitfire	p7 Jul 97 No.205
.....	p11 Nov 91 No.137,	Registering your car in France	p76 Jun 97 No.204,
.....	p14 Jan 92 No.139,	p6 Jul 97 No.205
.....	p9 Oct 92 No.148,	Registration Document	p13 Jan 86 No.67
.....	p9 Dec 93 No.162,	Registration Mark Format (New)	p8 Sep 01 No.255,
.....	p9 Nov 94 No.173,	Registration Marks	p8 Oct 01 No.256
.....	p9 Nov 95 No.185,	p9 Dec 82 No.30,
.....	p8 Jan 97 No.199,	p22 Mar 83 No.33,
.....	p8 Nov 97 No.209,	p44 Jul 83 No.37,
.....	p9 Apr 01 No.250	p36 Jul 84 No.49,
Loads	p12 Mar 85 No.57,	p10 May 85 No.59,
.....	p9 Aug 86 No.74,	p10 Dec 86 No.78,
.....	p11 Jun 88 No.96,	p25 Sep 88 No.99,
.....	p10 Jul 88 No.97,	p11 Sep 89 No.111,
.....	p11 May 89 No.107,	p79 Mar 92 No.141,
.....	p10 Jul 90 No.121	p9 May 92 No.143,
Mini-bus Permits	p9 Mar 90 No.117,	p9 Aug 92 No.146,
.....	p11 Jun 90 No.120	p18 Sep 92 No.147,
Mirrors	p8 Jan 93 No.151,	p9 Mar 93 No.165,
.....	p9 Jan 94 No.163,	p9 Jun 95 No.180,
.....	p8 Nov 96 No.197,	p10 Feb 97 No.200,
.....	p8 May 97 No.203	p74 Apr 97 No.202,
Mobile Phone Use	p10 Jan 04 No.283,	p26 Jan 00 No.235,
.....	p9 Aug 05 No.302	p9 Feb 00 No.236,
Motoring Manners	p12 Jan 88 No.91	p41 Mar 01 No.249,
Motorway Breakdown Procedures	p11 Nov 89 No.113,	p7 Nov 01 No.257
.....	p14 Oct 91 No.136,	Regulations - Early Index	p10 Apr 87 No.82
.....	p9 Nov 93 No.161,	Registrations Guide	p56 Dec 04 No.294
.....	p9 Oct 95 No.184,	Registration Swapping	p12 Oct 94 No.172
.....	p11 Jul 03 No.277,	Road Markings	p8 Aug 94 No.170,
.....	p11 Jun 04 No.288	p9 May 95 No.179,
Motorway Regulations	p9 Oct 89 No.112,	p8 Dec 95 No.186,
.....	p19 Sep 91 No.135,	p7 Jun 97 No.204,
.....	p9 Oct 93 No.160,	p9 Jun 05 No.300
.....	p9 Sep 95 No.183,	Roadworthiness Regulations	p8 Mar 97 No.201
.....	p11 Aug 03 No.278,	Safety Legislation (Spitfire)	p31 May 97 No.203
.....	p15 Apr 05 No.298	Seat Belts	p8 Oct 85 No.64,
MoT Tests	p10 Aug 89 No.110,	p17 Feb 86 No.68,
.....	p9 Aug 92 No.146,	p9 Jul 89 No.109,
.....	p9 Apr 97 No.202,	p10 Dec 89 No.114,
.....	p9 Oct 00 No.244	p10 Oct 90 No.124,
New Driver Class	p7 Sep 97 No.207	p9 Sep 92 No.147,
Number Plates, Licensing and Vehicle Checks	p11 Sep 94 No.171,
.....	p10 Jan 03 No.271,	p9 Oct 94 No.172,
.....	p53 Jul 03 No.277	p9 Jan 96 No.187,
Orange Indicators	p15 July 00 No.241	p9 Feb 96 No.188,
Organising Events	p9 Jun 01 No.252	p7 Mar 96 No.189,
Parking at Night	p111 Feb 03 No.272	p11 Sep 02 No.267,
Pet Hates	p38 Jan 99 No.223	p8 Oct 04 No.292,
Petrol (carrying & storing)	p19 Apr 85 No.58,	p9 Mar 05 No.297
.....	p11 Apr 88 No.94	Security	p13 Jan 86 No.67,
Petrol Tax	p77 Aug 00 No.242,	p6 Oct 86 No.76,
.....	p46 Sep 00 No.243	p11 Jun 89 No.108,
Photocard Driving Licences	p24 Dec 98 No.222	p22 Jan 91 No.127



Cop Shop Rules & Regulations Continued

<u>Item</u>	<u>Page & Issue No.</u>	<u>Item</u>	<u>Page & Issue No.</u>
Selling Cars	p7 Aug 97 No.206		p10 Nov 03 No.281,
Selling: Cars Road Worthiness	p26 Aug 99 No.230,		p11 Feb 04 No.284,
	p9 Mar 00 No.237,		p8 Feb 05 No.296
	p11 Apr 03 No.274	Tyres	p8 Jun 85 No.60,
Single Vehicle Approval	p30 Dec 97 No.210,		p8 Oct 85 No.64,
	p9 Feb 98 No.212		p11 Aug 88 No.98,
SORN, V5s and Regies	p61 Jan 98 No.211,		p15 Feb 89 No.104,
	p7 July 98 No.217,		p11 Mar 91 No.129,
	p9 Feb 00 No.236,		p18 Jun 91 No.132,
	p7 Nov 01 No.257,		p8 Mar 92 No.141,
	p5 Mar 04 No.285,		p8 Sep 93 No.159,
	p8 Sep 04 No.291,		p9 May 94 No.167,
	p72 Oct 04 No.292,		p9 Dec 94 No.174,
	p56 Dec 04 No.294,		p8 Aug 96 No.194,
	p78 Feb 05 No.296		p10 Apr 98 No.214,
Speed Cameras	p8 Oct 99 No.232		p7 Oct 98 No.220,
Speedometers	p10 Sep 90 No.123,		p7 Jan 02 No.259,
	p11 Dec 92 No.150		p15 Jun 03 No.276,
	p9 Jul 96 No.193		p11 Mar 04 No.285,
Speedos, Horns, Trailer Brakes	p10 Dec 03 No.282		p16 Sep 99 No.231,
Steering	p11 Sep 88 No.99,		p9 Feb 01 No.248,
	p8 Apr 90 No.118,		p11 Jul 04 No.289
	p15 Mar 93 No.153,	Vehicle Control	p11 Nov 04 No.293
	p9 Jun 94 No.168	Vehicle Defect Rectification Scheme	p4 Jul 86 No.73,
Selling a Defective Vehicle	p9 Aug 95 No.182		p7Aug 86 No.74
Selling (Unworthy Vehicle)	p8 Jul 01 No.253	Vehicle Excise Licence/Duty	p6 Dec 84 No.54,
Spitfire Rear Seats?	p8 Mar 99 No.225		p7 Jul 85 No.61,
Suspension	p11 Sep 88 No.99,		p11 Apr 88 No.94,
	p8 Apr 90 No.118,		p9 Jan 01 No.247
	p15 Mar 93 No.153,	Vehicle Seizure	p8 Sep 05 No.303
	p9 Jun 94 No.168	V5	p9 Feb 00 No.236,
Suspension, Brakes and Steering	p7 Nov 98 No.221		p7 Nov 01 No.257,
Tax Exempt Topics	p50 Jul 97 No.205,		p7 Dec 01 No.258,
	p52 Aug 97 No.206,		p6 Feb 02 No.260
	p38 Sep 97 No.207,	V5 Retrospective Registration (Specials)	p31 Dec 97 No.210,
	p51 Oct 97 No.208,		p30 Apr 98 No.214,
	p61 Dec 97 No.210,		p44 May 98 No.215
	p5 May 98 No.215	Waiting restrictions (Yellow Lines)	p9 May 95 No.179,
Tax Rebates	p79 May 00 No.239		p10 Jul 02 No.265
Three Wheelers	p8 Oct 85 No.64	Warning Lights	p12 Nov 99 No.233
Tired Engines	p16 Sep 99 No.231	Windscreens, Washers and Wipers	p10 Sep 90 No.123,
Towing	p9 Aug 86 No.74,		p8 Nov 92 No.149,
	p11 Jun 88 No.96,		p8,11Dec 92 No.150,
	p11 Aug 88 No.98,		p11 Apr 93 No.154,
	p10 Apr 89 No.106,		p9,11Apr 94 No.166,
	p10 May 90 No.119,		p24 May 94 No.167,
	p10 Jul 90 No.121,		p11 Oct 96 No.196,
	p19 May 91 No.131,		p8 Nov 96 No.197
	p8 Jun 93 No.156,	Winter Driving	p11 Feb 88 No.92,
	p12 Feb 94 No.164,		p11 Nov 88 No.101
	p9 Apr 95 No.178,		
	p9 May 98 No.215		
Tow Bar Fitting	p26 Dec 98 No.222		
Trailers	p10 Sep 90 No.123,		
	p8 Jan 93 No.151,		
	p8 Jan 95 No.175,		
	p9 Jul 96No.193,		
	p8 Apr 00 No.238,		
	p10 Feb 02 No.260,		



Item **Page & Issue No.**

GT6

Bodywork/Chassis:

Body Number Plate p50 July 98 No.217
 Bonnet-stay Mod p47 Sep 90 No.123
 Bumper Bolts p18 Jul 05 No.301
 Chassis Talk p27 Apr 90 No.130
 Chassis Outrigger p.28 Mar 84 No.45
 Composite Doors p24 Mar 05 No.297
 De-Seam a GT6 p28 Mar 85 No.57
 Door Fitting p16 Aug 05 No.302
 Floor & Sill Replacement p31 Apr 83 No.4
 (Turning Circle)
 Floor Replacement p63 Mar 92 No.141,
 p61 Apr 92 No.142,
 p61 May 92 No.143,
 p61 Jun 92 No.144,
 p67 Jul 92 No.145,
 p61 Aug 92 No.146
 Heel Panel Fault? p47 Nov 99 No.233
 Louvre Fitting p44 May 04 No.287
 Panel Interchangability p39 Mar 85 No.57
 Rear Quarterlight Mod. p5 Feb 81 No.8
 Rear Suspension Bump Stops ... p36 Jun 87 No.84
 Roof Repair p44 Oct 86 No.76
 Roof Edge Preservation p71 May 91 No.131
 Roof Panel Repair p77 Sep 94 No.171
 Roof Replacement p23 Mar 94 No.165
 Sill Replacement p43 Aug 85 No.62,
 p.22 Feb 86 No.68
 Spitfire Body Conversion p30 Nov 83 No.41
 Sunroofs p22 Oct 91 No.136,
 p75 Feb 92 No.140
 Windscreen Frame p17 Jul 82 No.25
 Wing Louvres p14 Feb 04 No.284

Brakes:

Brakes p47 Jan 91 No.27
 Brake Imbalance p16 Apr 84 No.46
 Brake Servos p21 Apr 90 No.118
 Brake Upgrading p38 Jul 04 No.289
 Girling Power Stop p27 Nov 97 No.209
 Rear Arch / Brake Pipe Mod p23 July 94 No.169,
 p38 Sep 94 No.171

Carburettors:

Carb Replacement p28 Aug 01 No.254
 K&Ns and GT6s p59 Oct 94 No.172,
 p65 Jan 95 No.175
 Low Profile Stromberg??? p10 Apr 05 No.298,
 p14 May 05 No.299
 Misfiring Tips p75 Jun 01 No.252
 P.I. Conversion p26 Nov 83 No.41,
 p23 Apr 95 No.178
 Strombergs p39 Jan 94 No.163
 Stromberg Carburettor Conversion . p21 Sep 89 No.111

Car Profiles/Buying:

BGT vs. GT6 p10 Sep 97 No.207

Item **Page & Issue No.**

Chevy 350 V8 Dragster p41 Jun 03 No.276
 Convertible GT6s p46 Aug 98 No.218
 Cutaway Mk1 p38 Feb 89 No.104
 Cutaway Mk3 p35 Nov 88 No.101
 Drophead GT6 p54 Aug 02 No.266
 First GT6 Mk.3 p33 Sep 01 No.255
 French GT6 p76 Sep 02 No.267
 GT6 Convertible p34 Nov 01 No.257
 GT6 Evolution p14 May 99 No.227,
 p41 Apr 00 No.238,
 p38 May 00 No.239
 GT6 Launch (Mk.1) p27 Oct 96 No.196
 GT6 Mk.4? Concept Sketches p48 Jan 02 No.259,
 p78 Feb 02 No.260,
 p14 Sep 02 No.267
 GT6+ p28 Jan 99 No.223
 Magazine Articles (National Press) p24 Feb 95 No.176,
 p11 Jun 97 No.204
 Mk3 Cutaway p38 Jun 89 No.108
 Mk.III Profile p50 Feb 95 No.176,
 p52 Mar 95 No.177
 Mk.2 p29 Jan 97 No.199
 MKII - CountryLife Magazine p26 Feb 85 No.58
 Mk2 Profile p41 Jun 89 No.108,
 p26 Aug 97 No.206
 Mk.2, 3 p44 Mar 97 No.201
 MKII Triumph GT6 (Autocar) p16 Apr 83 No.4
 (Turning Circle)
 Photo Gallery p28 Apr 01 No.250
 Racing GT6 (Peter Cox) p55 Jun 01 No.252
 Road Tests Survey p17 Feb 81 No.8,
 p6 Jul 81 No.13
 SAH Triumph GT6 (Motor) p10 Apr 83 No.4
 (Turning Circle)
 Tigger: Mk2 CPU 9G p30 Dec 01 No.258
 Triumph GT6 (Autocar) p3 Apr 83 No.4
 (Turning Circle)
 Triumph GT6 MKI p34 May 86 No.10
 (Turning Circle)
 Triumph GT6 MKIII p36 Apr 83 No.4
 (Turning Circle)
 Triumph GT6 MKII p26 Apr 83 No.4
 (Turning Circle)
 West Kent GT6s p68 Feb 02 No.260

Distributors/Ignition System:

Distributor Fitting/Timing p14 May 05 No.299

Electrical:

Alternator Fitting p43 Jun 02 No.264
 Door Light Switch p17 Aug 05 No.302
 Heated Rear Window p28 Apr 33 No.4
 (Turning Circle)
 Night Dimming Relay p36 Feb 89 No.104,
 p48, Apr 89 No.106

Engine/Ancillaries:

Crankshaft Pulley Bolt Removal ... p17 May 89 No.107



Item Page & Issue No.

Engine/Gearbox S seizure	p28 Dec 01 No.258
Engine Rebuild	p21 Sept 84 No.51
Engine Removal	p34 Apr 84 No.46
Engine Swop (2-2.5 litres)	p7 Feb 81 No.8
Engine Swop Pitfalls	p13 Jan 83 No.31
Flat/Domed Pistons	p24 Jun 05 No.300
Flywheel/Crankshaft Info	p46 Jan 05 No.295
Flywheels	p12 June 86 No.72
Fuel Consumption	p34 Jul 84 No.49
GT6 Trailer	p12 Apr 94 No.166.
Misfire Cured	p17 Sep 85 No.63
Oil Cooler -	p31 Jun 86 No.72
Misfire (Distributor)	p5 Aug 83 No.38
Misfiring Tips	p75 Jun 01 No.252
Oil Cooler Fitting	p39 Aug 02 No.266
Radiator Fans	p14 Mar 04 No.285
SAH Stage 3 GT6	p76 Apr 98 No.214
Six Cylinder Engine Code Letters	p54 Jan 04 No.283
Throttle Cables	p23 Jul 87 No.85
2-Litre Engines - Modified	p8 Nov 85 No.9 (Turning Circle)
2.5 Litre GT6 Conversion	p30 May 86 No.10 (Turning Circle)
2.5PI GT6	p54 Dec 99 No.234, p71 Mar 00 No.237
Unleaded Head Conversion	p36 Jul 01 No.253
Valve Spring Replacement	p17 Feb 85 No.56

General/Miscellaneous:

Books	p28 Feb 03 No.272
Buying Guide.	p55 Aug 90 No.122
Common Faults and Remedies	p30 Jul 96 No.193
Concours Custard	p31 Mar 00 No.237, p18 Apr 00 No.238
Convertible	p67 Oct 96 No.196
Engine / Brake / Suspension Up-rating	p22 Feb 97 No.200
GT6 Trailer	p33 Feb 05 No.296
Heating and Ventillation	p23 Oct 91 No.136
IVRs	p49 July 98 No.217, p32 Feb 99 No.224, p22 Jan 00 No.235, p10 Dec 00 No.246
Perils of Buying a GT6	p45 Apr 33 No.4 (Turning Circle)
Production Figures	p4 Aug 80 No.2
Racing a GT6?	p35 Nov 85 No.65
Racing GT6	p35 Oct 00 No.244, p14 Feb 01 No.248
Racing GT6 (Peter Cox's)	p52 May 01 No.251
Reference Material	p46 Apr 83 No.4 (Turning Circle)
Rustproofing Your GT6 p	28 Mar 96 No.189
Secure Stowage Space	p46 Nov 98 No.221
Service your GT6	p22 May 86 No.10 (Turning Circle), p18 Nov 96 No.197
Superweight GT6	p74 Oct 99 No.232

Item Page & Issue No.

Mechanicals (Other):

Steering Lock	p70 Jun 90 No.120
---------------	-------------------

Restoration/Rebuild Projects:

Angela & Andrew McGowan's GT6...	p70 Mar 96 No.189
Deadline Six Weeks (GT6 Restoration)	p23 May 86 No.10 (Turning Circle)
Do's and Don'ts BUF 548L	p60 Mar 01 No.249
Gertie's Story - Mk.3 Restoration	p68 Feb 04 No.284, p76 Mar 04 No.285
GT6 III Revived	p37 May 86 No.10 (Turning Circle) GT6
Restoration	p52 Dec 99 No.234, p63 Feb 00 No.236, p71 Mar 00 No.237, p74 May 00 No.239
Mk.1 Restoration	p46 July 00 No.241
Mk.3 Restoration	p18 Mar 00 No.237
Project Bonio (restoration)	p52 Dec 99 No.234, p63 Feb 00 No.236, p71 Mar 00 No.237, p74 May 00 No.239, p58 Feb 02 No.260, p68 Mar 02 No.261, p76 Jul 02 No.265
Rebuild	p25 Nov 82 No.29, p40 Apr 83 No.4 (Turning Circle)
Rebuilding Bluey	p58 Jan 97 No.199, p60 Feb 97 No.200, p56 Mar 97 No.201, p55 Apr 97 No.202
Restorations	p77 Jul 92 No.145, p71 Jan 93 No.151
Rot Box Restoration	p8 Jul 86 No.73
'SAD' Restoration	p23 Aug 00 No.242
SAL	p18 Jul 03 No.277

Suspension and Steering:

Bump Stops	p60 Mar 00 No.237, p46 Jun 00 No.240
Camber Change?	p42 Mar 85 No.57
Front Trunion Replacement	p20 Sept 81 No.15
Mk1 Rear Spring Mod.	p19 July 99 No.229
Rear End Blues (spring bush mod.)	p21 Oct 80 No.4
Rotoflex Shocks Conversion	p78 Jun 01 No.252
Shock Absorbers	p29 Aug 87 No.86
Steering Column Bush Replacement	p30 Jun 86 No.72
Steering Swivels	p23 Nov 83 No.41
Suspension Improvements	p32 Jun 84 No.48
Suspension Set-Ups	p25 Nov 85 No.65, p41 Feb 86 No. 68
Suspension/Tyre Trials	p28 Dec 92 No.150

Transmission:

Dolomite Sprint Gearbox Conversion	p23 Dec 84 No.54
------------------------------------	------------------



<u>Item</u>	<u>Page & Issue No.</u>	<u>Item</u>	<u>Page & Issue No.</u>
Engine/gearbox S seizure	p28 Dec 01 No.258	Headlining Replacement	p18 Apr 96 No.190
Gearbox Sizzle	p17 Feb 84 No.44	Head Up Display	p46 Aug 86 No.74
GT6 and 2000 Gearboxes	p79 Aug 00 No.242	Luggage Straps	p20 Jun 90 No.120
Halfshaft UJ Replacement (rubber doughnuts)	p7 May 86 No.71	Rear Deck Security Board	p43 Feb 87 No.80
Overdrive Conversion	p36 Oct 01 No.256,	Rear Seats	p24 May 93 No.155,
	p32 Nov 01 No.257,		p28 Nov 03 No.281,
	p28 Dec 01 No.258		p28 Dec 03 No.282,
Overdrive Propshaft Alternative	p29 Sept 83 No.39		p54 Jan 04 No.283
Propshaft Balancing	p17 Feb 84 No.44	Seat Cover Replacement	p33 Jun 89 No.108
Rotoflex Rear Suspension	p14 Oct 89 No.112,	Wheel Trim Tip	p70 May 91 No.131
	p63 Jan.90, No.115,	Windscreen Sealing	p30 Sep 04 No.291
	p71 Mar 90 No.117		
Rotoflex & UJ Renewal	p33 Oct 83 No.40,	Wheels and Tyres:	
	p30 Nov 83 No.41	Alloy Wheels	p48 Apr 04 No.286
Vibration Solved (prop.)	p20 May 83 No.35	Suspension/Tyre Trials	p28 Dec 92 No.150
		Wheels and Tyres	p21 Jul 89 No.109
		Tyre Pressures	p46 Jan 88 No.91
Trim:		Workshop Techniques:	
Bulkhead Boots	p12 Apr 05 No.298	Lead Loading on GT6's	p33 Jun 86 No.72
Engine Valence Fitting	p15 Feb 04 No.284		
Gearbox Tunnel Insulation	p59 Aug 93 No.158		

HERALD



<u>Item</u>	<u>Page & Issue No.</u>	<u>Item</u>	<u>Page & Issue No.</u>
<u>Herald</u>		Outrigger Repairs	p48 May 04 No.287
Bodywork/Chassis:		Paint & Trim Codes	p6 May 81 No.11,
Body Bracket Replacement	p51 Dec 91 No.138		p17 Jun 87 No.84
Body Fitting	p51 Dec 92 No.150,	Panel Gap Setting	p14 Aug 03 No.278
	p11 Dec 95 No.186,	Rear Body Tub Repairs	p51 Jan 92 No.139
	p11 Jan 96 No.187,	Rear Outrigger Replacement	p41 Dec 83 No.42
	p29 Feb 96 No.188	Rear Valences	p29 Dec 99 No.234
Body Lifting	p77 Sep 92 No.147	Rear Wing Replacement	p51 Jul 91 No.133,
Body Removal	p24 Jun 86 No.72,		p51 Aug 91 No.134
	p51 Sep 91 No.135,	Replacing Door Tread Plates/ Floor Pan Edges	p17 Nov 81 No.17
	p47 May 92 No.143	Roof Removal	p12 Dec 82 No.30,
Boot Floors	p30 Dec 99 No.234		p34 Aug 92 No.146
Bonnet Bracket Extentions	p29 Apr 87 No.82	Rust Prevention	p19 Feb 83 No.32
Chassis Design	p15 Jan 87 No.79	Saloon to Convertible Conversion	p13 Jun 82 No.24,
Chassis Explained	p11 Aug 81 No.14		p17 Nov 84 No.7
Chassis Rail Rot	p24 Nov 84 No.53		(Turning Circle),
Chassis Rebuild	p51 Oct 92 No.148		p29 Apr 88 No.94,
Chassis Repairs	p51 Oct 91 No.136,		p57 Aug 88 No.98
	p51 Nov 91 No.137	Seat belt mounting point repair	p28 Dec 97 No.210
Chassis Side Rails	p18 Sept 82 No.27,	Splitting Bumpers	p24 Sep 87 No.87
	p.22 Dec 82 No.30	Tristan Convertible Kit	p7 Jul 92 No.145,
Door Reskinning	p51 Apr 89 No.106		p18,45 Oct 92 No.148
Doors - Rattles & Rust. The Cure!	p23 Dec 83 No.42,		p70 May 93 No.155
	p.20 May 84 No.47	Water Leak Sorting	p14 Jul 93 No.157
Floor Pan Repair	p14 Aug 93 No.158	Wheel Arch Repair Panels	p11 Feb 82 No.20
Front Valence Repair	p24 May 87 No.83		
Hard Top Revisited	p52 Feb 86 No.68	Brakes:	
Mk1 Chassis Weakness	p28 Jul 05 No.301	Brake Bleed Nipples	p22 Nov 87 No.89
948 Windscreen Seals	p6,15 Apr 90 No.118	Brake Pads (Kevlar)	p25 Aug 05 No.302
Original Paint Finishing	p21 Jul 86 No.73	Brakes MOT Fail	p10 Jun 05 No.300



Item	Page & Issue No.
Brakes (Part Numbers)	p23 Oct 83 No.40
Brakes Parts Interchangeability	p14 Oct 81 No.16
Disc Brake Conversion	p30 Oct 81 No.1 (Turning Circle)
Front Brakes	p17 May 86 No.71
Rear Brakes and Hubs	p26 May 96 No.191

Carburettors:

Air Filters	p19 Aug 94 No.170
Belgian Herald	p44 Oct 04 No.292
Cold Air intake	p33 Aug 82 No.26
H1 SU Needles	p41 Mar 88 No.93 p50 Jun 88 No.96
K&N Air Filters	p29 Jan 97 No.199 p19 Feb 97 No.200
Needles & Carbs	p14 Jul 04 No.289
Single Carb Spitfire	p22 Nov 98 No.221
Single or Twin Carbs	p18 Jun 04 No.288
Solex Carburettors	p13 Jan 82 No.19 p16 Jan 97 No.199
1200 Carbs	p49 Nov 86 No.77 p38 Jan 87 No.79
Twin Carbs	p13 Oct 82 No.28

Car Profiles/Buying:

Airfix Kit	p14 July 00 No.241
Australian Herald	p22 Oct 86 No.76
Birth of the Herald	p76 May 02 No.263
Brabham Herald Replica	p50 Aug 05 No.302 p56 Sep 05 No.303 p60 Oct 05 No.304
Buying Guide	p53 Sep 90 No.123
Coupe Cutaway	p34 Jul 88 No.97 p44 Aug 02 No.266
Courier Van	p27 Aug 83 No.38 p34 Mar 84 No.45 p38 Jun 84 No.48 p11 May 90 No.119 p10 Mar 00 No.237 p40 Aug 04 No.290
Coventry Climax Herald	p31 Sep 96 No.195, p64 Jun 02 No.264
Earliest Saloon?	p32 Aug 01 No.254, p29Mar 03 No.273
Estate or Courier?	p14 Jun 01 No.252
Four Doors?	p11 Sep 00 No.243, p18 Apr 01 No.250
Gazel	p 23 Oct 90 No 124
Handley Page Herald	p58 Feb 01 No. 248
Herald 'S'	p11 Feb 82 No.20, p48 Sep 01 No.255, p34 Mar 02 No.261, p50 Oct 03 No.280
Indian Herald/Triumphs	p24 Jan 03 No.271, p58 Feb 03 No.272, p68 Mar 03 No.273, p68 Jul 03 No.277, p55 Dec 03 No.282, p45 Oct 04 No.292,

Item	Page & Issue No.
.....	p29 Jul 05 No.301, p32 Nov 05 No.305
Jack Brabham's Herald Climax	p51 Jun 90 No.120
Last of the Summer Wine	p20 May 02 No.263
Mantlepiece Herald	p24 Feb 03 No.272
90HP Herald 1200 Convertible	p41 Aug 84 No.50 948 p16 Feb 83 No.32, p22 Apr 33 No.34, p27 Jun 83 No.36
948 Bibliography p1	P8 Nov 89 No.113
948 Convertible	p45 Jul 90 No.121, p50 Nov 01 No.257
948 Coupe	p24 Apr 84 No.46
948 Profile	p57 Nov 89 No.113
Norwegian Herald	p29 Jul 02 No.265
Police Panda Herald	p64 Nov 03 No.281
Scandinavian Brochures	p26 Feb 02 No.260
Standard Gazelles	p19 Jun 90 No.120
Supercharged Herald	p66 Dec 02 No.270
13/80 Herald	p17 Nov 86 No.77
13/60 Identification and Purchase	p22 Sep 92 No.147, p29 Oct 92 No.148, p22 Nov 92 No.149, p38 Dec 92 No.150 p22 Jun 03 No.276
13/60 Ownership	p22 Jun 03 No.276
13/60 Profile	p41 Apr 89 No.106, p21 Dec 89 No.114
Time Capsule Coupe	p48 Dec 01 No.258
'Tiny' Lewis The Herald Years	p4 Jan 03 No.271, p74 Feb 03 No.272
Tristan Convertible	p14 Mar 02 No.261
Triumph Herald Convertible	p42 Mar 96 No.189
Tulip Rally Herald	p58 Nov 02 No.269
12/50	p7 Dec 90 No.126, p14 Apr 93 No.154
12/50 Convertibles	p24 Dec 00 No.246
12/50 Cutaway	p38 Mar 89 No.105
12/50 Saloon	p22 Aug 82 No.26
1200 Estate	p21 Aug 90 No.122
1200 Bibliography	p27 Feb 92 No.140
1200 Convertible Mk.1	p23 Jan 94 No.163, p11 Apr 94 No.166
1200 Coupe Profile	p65 Jul 91 No.133, p22 Dec 91 No.138
1200 Guide	p16 Dec 85 No.66, p14 Jan 86 No.67, p43 Feb 86 No.68, p34 Jun 86 No.72
1200 Launch and Production	p18 Apr 92 No.142
1200 Profile	p56 Jul 96 No.193
Two Tone	p16 Jul 02 No.265
White or Pink?	p68 Aug 05 No.302
Yimkin Conversion Herald	p27 Feb 02 No.260
Distributors:	
Distributor Caps	p18 May 88 No.95
1200, 13/60 Distributors	p17 Jun 89 No.108
Electrical:	
Alternator for Herald	p26 Aug 85 No.62



Item

Page & Issue No.

Fuses	p41 Nov 02 No.269
Lighting Equipment Checks	p36 Jan 90 No.115
Sidelight Adaptor Plates	p28 Apr 04 No.286
Side Repeater Lamp Fitting	p14 Jun 00 No.240
Tail Light Repair	p48 Jan 04 No.283
1200 Front Sidelamps	p23 Nov 88 No.101
Wiper Flick Switch	p20 Jun 03 No.276

Engine/Ancillaries:

Engine Interchange	p8 Sept 91 No.15, p.23 Jan 82 No.19
Engine Prefixes	p10 Jul 05 No.301
Engine Rebuild Tips	p32 Apr 86 No.70
Engines and Camshafts (1200)	p35 Jun 86 No.72
Engine Swoop	p54 Dec 88 No.102
Engine Swoop (Toledo)	p16 May 82 No.23
Exhaust System	p10 Apr 82 No.22, p16 Jun 82 No.24
Fan Blades	p10 Jan 98 No.211
Front Engine Mounts	p12 Mar 81 No.9
Oil Filter (High Capacity)	p16 Nov 05 No.305
Oil Leaks	p18 Jan 04 No.283, p16 Apr 04 No.286
Overheating Heralds	p10 Nov 93 No.161, p11 Jan 94 No.163
Overheating Tip	p70 Jun 00 No.240
Pinking	p20 Aug 87 No.86
13/60 Engines	p32 Mar 88 No.93
13/60 Tuning	p32 Jun 96 No.192
1200 Engine Mechanics	p10 Jul 86 No.73, p11 Sep 86 No.75
1200 Engine Rebuild Tip	p32 Apr 86 No.70
1200 'head water delivery tube	p60 Oct 99 No.232
Upgrading the 1147cc Engine	p15 Oct 80 No.4, p19 Oct 80 No.4
Valve Clearances/Tappets	p5 Aug 83 No.38
Visco Static 100,000 mile test	p5 Mar 84 No.45

Exhaust Systems:

Exhausts	p36 Apr 03 No.274
Manifold Connection	p22 Jul 88 No.97
948/1200 Exhaust Systems	p24 Nov 90 No.125

General/Miscellaneous:

Accessories Listing	p10 Jul 97 No.205
Boot Rack	p18 Jan 00 No.235
Build/Country Codes	p29 Jun 97 No.204
Commission & Engine Numbers	p10 May 82 No.23, p16 Jul 82 No.25, p12 Sept 82 No.27, p18 May 84 No.47, p.36 Jun 84 No.48, p23 Jul 84 No.49, p36 Sep 84 No.51, p24 Oct 84 No.52, p27 Jul 85 No.61, p21 Oct 85 No.64, p19 Apr 99 No.226
Commission Plates	p7 Aug 93 No.158

Item

Page & Issue No.

General Tips	p18 Oct 02 No.268, p29 Nov 02 No.269, p22 Jan 03 No.271
Grille Badge History	p23 Nov 03 No.281
Herald 1500 HL	p43 Jan 86 No.67
Hillclimbing: Car Preparation	p3 May 81 No.11
Identification Numbers/Plates	p30 Mar 01 No.249, p18 Apr 01 No.250
Improve your Estate	p33 May 89 No.107
Improvised Hardtops?	p50 Mar 05 No.297, p44 May 05 No.299
IVRs	p47 Sept 98 No.219, p22 Jan 99 No.223, p18 May 99 No.227, p10 Oct 99 No.232, p35 Apr 00 No.238, p34 Sep 00 No.243, p10 Oct 00 No.244, p10 Feb 01 No.249, p75 Aug 01 No.254, p66 Oct 01 No.256, p32 Dec 01 No.258, p29,44 Mar 03 No.273, p15 Mar 04 No.285, p10 Sep 04 No.291, p10,81 Jul 05 No.301
Leak Sorting	p21 Mar 89 No.105
948 Body Numbers	p18 Jan 89 No.103
Oldest Herald?	p22 Nov 99 No.233
Overseas Chassis Numbers	p29 May 86 No.71
Part Numbers	p13 Mar 81 No.9
Passing the MOT	p7 Jun 81 No.12
Period Accessories	p38 Nov 89 No.113
Period Ads.	p42 Oct 99 No.232
Production Figures	p7 May 81 No.11
Production Register Figures	p44 Feb 86 No.68
Registration Marks	p33 Feb 90 No.116
Repair Times	p19 Dec 89 No.114
Seatbelts	p68 Mar 96 No.189
Service Items	p15 Sep 89 No.111
Service Sheet 13/60:	p42 Jan 97 No.199
Servicing: 13/60:	p46 Jul 90 No.121
Servicing Your Herald	p23 Oct 95 No.184, p27 Nov 95 No.185, p33 Dec 95 No.186, p28 Jan 96 No.187, p10 Mar 96 No.189, p26 May 96 No.191, p32 Jun 96 No.192
12/50 Body Numbers	p15 May 89 No.107
1200 Body Numbers	p26 Feb 89 No.104
1200 Mk2 Coupe/Conv.Body Nos	p18 Jul 89 No.109
1200 Mk2 Saloon Body/Comm.Nos	p18 Oct 89 No.112
Tuning Kits	p55 Aug 89 No.110, p18 Aug 97 No.206

Mechanicals (Other):

Door Locks	p66 Feb 97 No.200
Grommets, Dust Seals (Part Nos.)	p20 Sept 83 No.39



Item	Page & Issue No.
Heater Guide	p25 Jan 85 No.55
Heater Overhaul	p66 Mar 96 No.189
Petrol Tanks	p24 Sep 88 No.99, p21 Feb 89 No.104
Petrol Tank Removal	p28 Nov 00 No.245
Petrol Tank Repair	p66 Feb 90 No.116
Seat Belt Fitting.....	p18 Oct 97 No.208, p63 Dec 97 No.210
Speedo Cable Replacement	p19 Jul 95 No.181
Tow Bar Fitting	p32 Aug 96 No.194

Paint:

948 Paint Colours	p25 Aug 91 No.134
Paint Codes	p40,Dec 98 No.222
Paint Detailing	p31 Apr 90 No.118

Restoration/Rebuild Projects:

Courier Van Rebuild	p35 Jan 86 No.67, p37 Feb 86 No.68, p22 Mar 86 No.69, p19 Apr 86 No.70, p21May 86 No.71
Estate Rebuild	p17 Nov 82 No.29, p11 Dec 82 No.30, p15 Jan 83 No.31, p17 Feb 83 No.32, p15 May 83 No.35, p13 Jan 84 No.43, p.19 Mar 84 No.46
Estate Restoration (Portugal)	p50 Feb 04 No.284
Herald/Vitesse Rebuild	p31 Apr 84 No.46
Herald/Vitesse Restoration	p50 Feb 91 No.126, p63 Mar 91 No.129, p51 Apr 91 No.130 p51 May 91 No.131, p51 Jun 91 No.132, p51 all issues Jul 91 No.133 to Jun 92 No.144, p51 all issues Jul 92 No.145 to May 93 No.155 except p55 Feb 93 No.152
Miniature Triumphs	p56 Dec 98 No.222
948 Restoration	p60 Feb 99 No.224, p74 Mar 99 No.225, p64 Apr 99 No.226, p78 May 99 No.227
Polish Restoration	p61 Jan 91 No.127
Rebuild Projects	p38 July 00 No.241, p46 Oct 01 No.256, p36 Dec 01 No.258, p38 Jan 02 No.259, p28 Apr 02 No.262, p14 Aug 02 No.266, p64 Apr 03 No.274, p42 Feb 04 No.284, p62 Jan 05 No.295, p27 Feb 05 No.296

Item	Page & Issue No.
Rebuild Schedule	p38 Jul 97 No.205
13/60 Estate UKO 635H Rebuild	p63 Apr 89 No.106, p67 May 89 No.107

Suspension and Steering:

Dampers explained	p38 Oct 97 No.208
Early Wishbones	p26 Feb 05 No.296
Estate Rear Springs	p19 Dec 80 No.6
Front Suspension	p5 Jul 81 No.13
Front Suspension Parts / Interchangeability	p14 Oct 81 No.16, p21 Sep 88 No.97
Rear Spring Data	p79 Jul 91 No.133
Springs	p26 Sep 97 No.207
Steering Column Top Bush Replacement	p38 Aug 85 No.62
Steering Racks	p8 Oct. 82 No.28, p15 Nov 82 No.29, p24 Feb 91 No.128, p55 Mar 91 No.129, p25 May 91 No.131
Suspension Mods	p27 Jan 84 No.43
Suspension Noise Fault Finding	p18 Nov 90 No.125, p27 Dec 90 No.126, p50 Jan 91 No.127
Swing Spring Conversion	p18 Oct 94 No.172, p11 Nov 94 No.173, p67 Dec 94 No.174, p15 Feb 95 No.176, p46 Aug 99 No.230

Transmission:

Clutch Conversion	p43 Mar 85 No.57
Clutch Overhaul/Interchangeability	p12 Jan 82 No.19, p26 Feb 84 No.44
Clutch Parts	p20 Jul 88 No.97
Clutch Removal and Replacement	p18 Aug 88 No.96
Differentials	p13 Mar 82 No.21, p10 Dec 82 No.30
Gearbox Alternatives	p27 Oct 91 No.136
Hubs and Half Shafts	p22 Feb 85 No.56
Overdrive	p24,38 Sep 84 No.51 p21 Nov 84 No.53, p39 May 85 No.59
Overdrive Conversion	p38 May 92 No.143, p22 Jun 92 No.144
Overdrive Tip	p65 May 98 No.215
Overdrive Units	p9 May 82 No.23, p33 Dec 82 No.30
Propshafts	p28 Nov 85 No.65
Rear End Knock	p42 Dec 85 No.66
Rear Hub Oil Seal Renewal	p21 Mar 83 No.33
Rear Trunnion Change	p32 Mar 85 No.57
Stub-Axle Examination	p16 Oct 84 No.52

Trim:

Bumper Rubbers	p11 Sep 96 No.195
Convertible Hood Folding	p38 Jul 88 No.97, p11 Sep 88 No.99



Item	Page & Issue No.
Door Seals	p30 Nov 04 No.293, p38 Dec 04 No.294, p51 Mar 05 No.297
Doorseal Substitute	p55 Jun 89 No.108
Fuel Tank Sticker	p24 Sep 88 No.99
Headlining Replacement	p51 Mar 93 No.153
Metro Seats in a Herald	p18 Mar 99 No.225
Overriders	p14 Apr 97 No.202
Paint & Trim Codes	p6 May 81 No.11, p17 Jun 87 No.84
Parcel Shelf Modification	p63 Nov 96 No.197, p53 Jan 97 No.199
Re-Hood	p39 May 85 No.59
Seat Problems	p75 Dec 92 No.150
Seat Recovering	p51 May 92 No.143, p51 Jun 92 No.144
Seat Rebuild	p74 Dec 99 No.234, p61 Mar 00 No.237
Seat Repair	p19 Sep 97 No.207

Item	Page & Issue No.
Soft Top Fitting	p51 Apr 92 No.154
Sun Roof Repairs	p27 Oct 93 No.160
13/60 Soft Top	p17 Dec 82 No.30
Tonneau Cover Support	p25 Mar 90 No.117
White Rubber Bumpers	p33 Nov 82 No.29, p12 Aug 95 No.182

Wheels and Tyres:

Cross-ply vs Radials	p14 Nov 97 No.209
Tyre Wear	p13 Mar 82 No.21
Tyres and Wheels	p33 Dec 84 No.54, p34 May 85 No.59
Wheels and Tyres	p30 Jan 85 No.55, p18 Oct 87 No.88, p34 Jul 89 No.109, p10 Jan 99 No.223, p18 Apr 99 No.226, p30 Jan 00 No.235, p26 Feb 00 No.236

SPECIALS



Item	Page & Issue No.
<i>Specials</i>	
Specials Listing:	
AKS	p40 Dec 04 No.294
AKS Continental	p24 Oct 84 No.52, p51 Feb 97 No.200
Askew	p20 Jun 02 No.264
AWE Roadster	p32 Sep 96 No.195, Cover Apr 97 No.202, p25 Oct 90 No.124, p19 Mar 91 No.129, p27 Aug 94 No.170, p16 Jun 99 No.228, p70 Apr 03 No.274, p46 May 03 No.275
Burlington	p21 Nov 81 No.17, p15 Apr 87 No.82, p16 May 97 No.203, p29 Jan 93 No.151, p14 Jul 05 No.301
Burlington Arrow (All Steel)	p11 Mar 94 no.165
Burlington Arrows	p22 Dec 00 No.246, p37 Jan 05 No.295, p21 Mar 05 No.297
Burlington Arrow/Chieftan	p20 Mar 03 No.273, p22 Oct 03 No.280
Burlington Berreta	p28 Oct 93 No.160, p20 Oct 01 No.256, p36 Nov 01 No.257, p28 Jan 02 No.259, p36 Jul 02 No.265, p20 May 04 No.287,

Item	Page & Issue No.
Burlingtons	p19 Jul 04 No.289 p42 Sep 97 No.207, p29 Dec 98 No.222, p16 Jun 99 No.228
Burlington SS	p18 Apr 84 No.6 (Turning Circle), p36 Aug 01 No.254 p21 Dec 01 No.258, p30 Mar 02 No.261, p38 Apr 04 No.286
Burlington to Le Mans	p18 Mar 03 No.273
Buying a Gentry Secondhand	p28 Feb 01 No. 248
Cadbury's Creme Egg	p36 Jun 02 No.264
Cawthorne Special	p19 Oct 95 No.184
Condor	p31 Dec 87 No.85
Cook Island Kit?	p14 Aug 05 No.302
Dingbat	p74 Jan 98 No.211
Douglas TF	p33 Oct 91 No.136, p7 Nov 97 No.209, p16 Jun 99 No.228, p52 May 05 No.299 p14 Jul 05 No.301
Dutton Malaga	p18 Oct 05 No.304
Dutton Phaeton Series I	p24 Apr 84 No.6 (Turning Circle)
Dutton Spider	p48 Jun 03 No.276
Fairthorpe Rockette	p28 Apr 89 No.106
Falcon Caribbean	p35 May 92 No.143 p40 Dec 04 No.294, p20 Mar 05 No.297, p50 May 05 No.299
Fowler Steam Roller	p46 May 04 No.287



SPECIALS

<u>Item</u>	<u>Page & Issue No.</u>	<u>Item</u>	<u>Page & Issue No.</u>
Gentry	p13 Oct 81 No.16, p40 Apr 84 No.6 (Turning Circle), p26 Mar 93 No.153, p14 Jun 99 No.228, p42 May 98 No.215, p33 Aug 00 No.242, p18 Nov 00 No.245, p28 Feb 01 No. 248, p22 Mar 01 No.249, p44 May 02 No.263, p38 Nov 03 No.281, p24 Mar 04 No.285, p10 Nov 04 No.293		p30 Mar 84 No.45, p27 Jul 86 No.73, p22 Apr 97 No.202,, p10 Apr 01 No.250, p38 Jan 05 No.295, p29 Apr 05 No.298 p54 Dec 02 No.270, p68 Apr 03 No.274
Gibbs Aquada	p63 Nov 03 No.281	Marlins & More	p32 Apr 98 No.214
Ginetta G33	p29 Sep 00 No.243	Michael Perry Special	p28 Nov 99 No.233
GT7	p37 Jul 02 No.265, p24 Oct 02 No.268, p14 Nov 02 No.269, p15 Aug 05 No.302	Midge	p11 Feb 00 No.236, p28 Mar 00 No.237, p18 Jun 00 No.240, p32 Jul 01 No.253, p68 Sep 01 No.255, p46 Apr 02 No.262
GW Phoenix	p32 Dec 03 No.282	Midge and Locust	p14 Jun 99 No.228
Hooper/Lindy	p30 Aug 91 No.134, CoverDec 91 No.138,	Midge and Locust Live	p38 Apr 95 No.178
	p10 Mar 92 No.141, p38 Jan 96 No.187	Mini E-Type	p23 Nov 93 No.161
Hurricane	p21 Jun 83 No.36, p22 Apr 91 No.130, p14 Jun 95 No.180, p8 Nov 98 No.221, p8 Apr 99 No.226, p15 Jun 99 No.228, p10 Feb 00 No.236, p16 Jul 04 No.289, p8 Nov 04 No.293, p28 Jun 05 No.300, p14 Nov 05 No.305	Moss	p16 Jun 99 No.228
	p49 Apr 84 No.6 (Turning Circle)	Moss History	p60 Jan 03 No.271
JC Midge	p19 Sep 90 No.123, p10 Apr 93 No.154, p31 Jul 93 No.157, p49 Jun 03 No.276	Type 48 Register	p56 Dec 02 No.270
John Box Special	p32 Aug 03 No.278	Moss Malvern	p19 Oct 00 No.244, p16 Aug 04 No.290
Ken Bland's Special	p30 Mar 86 No.69	Moss Mamba	p8 Oct 04 No.292
Kit Cars on the Net	p229 Jan 02 No.259, p20 Feb 02 No.260	Moss Monaco	p28 July 00 No.241, p10 Jan 01 No.247, p30 Jul 03 No.277
Kit Choice	p29 Mar 88 No.93, p26 May 88 No.95	Moss Roadster	p32 Apr 84 No.6 (Turning Circle) p18 Sep 04 No.291
Latham F2 Super Sports	p38 Jan 04 No.283		p34 Feb 90 No.116
Lenham Factory	p70 Jul 96 No.193	Moss and Gentry	p18 Nov 95 No.185
Locust	p18 May 94 No.167, p11 Dec 96 No.198, p15 Aug 05 No.302	Moss Cars (Bath) Ltd.	p14 Apr 96 No.190
Low Cost Special	p18 Feb 89 No.104	Moss Malvern	p10 Aug 95 No.182, p28 Jan 00 No.235
Malvern	p25 Feb 03 No.272	Moss Mamba	p42 Aug 93 No.158
Marcos	p19 Oct 05 No.304	Moss Monaco	p11 Dec 94 No.174
Marlin	p7 Dec 81 No.18, p26 Apr 84 No.6 (Turning Circle),	Omaha Special	p33 Aug 03 No.278, p24 Oct 03 No.280
		Peerless	p14 Feb 05 No.296
		Phoenix	p59 May 94 No.167
		Quantum	p21 Jun 02 No.264
		Rosanatti	p26 Oct 83 No.40
		Royale	p23 Jul 95 No.181
		Six Pot Midge	p7 Sept 81 No.15, p10 Apr 93 No.154, p18 Jun 01 No.252
		Spartan	p19 Feb 84 No.44
		Spartan 2+2 on Vitesse Chassis?	p71 Sep 01 No.255, p31 Mar 02 No.261
		Spitfire Based Kits	p71 Oct 91 No.136
		Spitfire Special	p49 Mar 92 No.141
		Steam Powered Falcon	p59 Oct 90 No.124
		Squirrel Cars	p19 Mar 91 No.129, p65 Mar 04 No.285
		Stanbury TT	p28 Apr 00 No.238, p14 May 00 No.239, p18 Jun 00 No.240
		T&J Locust	

SPECIALS



Item	Page & Issue No.
Tardis, Stuart-Williams	p28 May 01 No.251
Triumph Super Seven	p79 Feb 05 No.296
TX Tripper	p7 May 82 No.23, p18 May 90 No.119, p33 Jun 90 No.120, p21 Sep 90 No.123, p36 Jan 04 No.283
Type 48	p26 July 94 No.169, p29 Aug 98 No.218, p54 Oct 98 No.220, p15 Jun 99 No.228, p16 July 99 No.229, p28 Apr 05 No.298
Type 48 Spyder	p22 Aug 96 No.194, p44 Mar 98 No.213, p18 Oct 00 No.244, p23,p54Dec00No.246 p6 Feb 01 No.248, p31 Mar 02 No.261, p34 Aug 03 No.278, p32 Jun 04 No.288, p48 Sep 05 No.303
Type 35 Bugatti	p18 Mar 95 No.177, p20 Feb 04 No.284
Vale Special	p22 Feb 99 No.224
Vincent Hurricane	p44 May 03 No.275
Vincent MPH	p38 Feb 94 No.164
Vitesse 1600 Special	p57 Nov 95 No.185
YKC Sports Cars	p228 Jan 02 No.259

Construction/Tips/General:

Avoid the Q	p38 May 95 No.179
Cost and Value	p22 Jun 88 No.96
Custom Suspensions	p8 Sep 92 No.147
Dashboard Tips	p26 Mar 89 No.105
Donor Cars	p26 Jan 84 No.43, p32 Mar 84 No.45
Exhausts	p28 Dec 98 No.222, p46 Mar 99 No.225

Item	Page & Issue No.
Electronic Rev Counter Tip	p32 Jul 93 No.157
Falcon Caribbean Rebuild	p24 Oct 85 No.64, p51 Feb 97 No.200
Gentry 722 DUK	p32 Dec 99 No.234
Herald Based Specials?	p30 Mar 00 No.237
Hurricane Reborn	p24 Aug 96 No.194
Marlin Construction	p13 Jun 81 No.12, p20 Aug 81 No.14, p21 Feb 83 No.32
Miss Genevieve	p18 Feb 96 No.188
Morgan You'd Expect	p50 Sept 98 No.219
Moss Rebuild	p8 Sep 99 No.231, p28 Oct 99 No.232
Rear Camber Tips	p29 Mar 97 No.201
Rear Suspension Load Levellers	p14 Jan 82 No.19
Registration & SVA	p33 Jan 99 No.223
Retrospective Registration	p31 Dec 97 No.210, p31 Dec 97 No.210, p30 Apr 98 No.214, p44 May 98 No.215
Saint (Construction)	p14 Apr 84 No.6 (Turning Circle)
Security Measures	p26 Mar 89 No.105, p53 May 89 No.107
Sidelights	p6 May 83 No.71
Single Vehicle Approval	p30 Dec 97 No.210, p9 Feb 98 No.212, p37 Jan 05 No.295
Six Pot Spartan	p31 Jan 99 No.223
Spartans (Construction)	p10 Apr 84 No.6 (Turning Circle)
Spartan - Reverse Gear Lock	p20 Dec 84 No.54
Springs	p16 Aug 04 No.290, p72 Sep 04 No.291
Suspension Set Up	p22 Mar 01 No.249
Suspension Uprating (Hurricane)	p8 Nov 04 No.293
T&J Locust Build	p28 Apr 00 No.238, p14 May 00 No.239
Wooden-bodied Specials	p8 Sept 98 No.219

SPITFIRE



Item	Page & Issue No.
Spitfire	
Bodywork/Chassis:	
Aerodynamics of a Spitfire	p30 Apr 95 No.178
Body Removal	p63 Apr 93 No.154, p63 May 93 No.155
Bodyshell Strip	p71 Jul 93 No.157, p70 Aug 93 No.158
Bodywork	p62 Oct 03 No.280
Bodywork Condition Review	p29 May 92 No.143
Bonnet Adjustment	p23 Oct 87 No.88
Bonnet Care	p33 Dec 89 No.114
Bonnet Hinge Box Replacement	p70 Jan 94 No.163.

Item	Page & Issue No.
Bonnet Panel Repair	p18 Feb 94 No.164.
Bonnet Stay Arrangement	p19 Feb 93 No.152
Bonnet Ventilation Grill	p24 Jun 04 No.288
Bumper Raising	p59 Jan 04 No.283
Chassis Repairs	p70 Dec 93 No.162
Chassis Torsional Stiffness	p54 Mar 03 No.273
Corrosion Check Points	p58 May 04 No.287
De-Seam A Spitfire	p28 Mar 85 No.57
Door Dimensions	p47 May 02 No.263
Early Chassis	p14 Feb 92 No.140
Fastback Hardtop	p19 Apr 90 No.118
Fibreglass Panels/Bonnets	p28 Aug 95 No.182, p14 Nov 95 No.185,

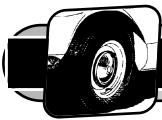

SPITFIRE

Item	Page & Issue No.	Item	Page & Issue No.
	p14 Jan 96 No.187,		p53 Sep 96 No.195
Floor Replacement	p26 Feb 96 No.188	Waxstat Blues Cure	p57 Feb 89 No.104
	p63 Mar 92 No.141,		
	p61 Apr 92 No.142,	Car Profiles/Buying:	
	p61 May 92 No.143,	ADU 4B	p8 Dec 04 No.294
	p61 Jun 92 No.144,	ADU 3B	p7 Oct 89 No.112
	p67 Jul 92 No.145,	Adverts	p36 May 01 No.251,
	p61 Aug 92 No.146		p54 May 04 No.287
Front Valance Notes	p23 Feb 93 No.152	Australian Mk.2 Improvements	p60 Nov 00 No.245
Grills (Early)	p38 May 94 No.167	Automatic Spitfire?	p42 Apr 05 No.298,
Hardtops	p14 Sept 82 No.27		p60 Aug 05 No.302
Hard Top Fitting	p11 Aug 94 No.170,	Buying a Secondhand Spitfire IV/1500	p27 May 85 No.8
	p54 Nov 03 No.281,		(Turning Circle)
	p79 Feb 05 No.296	Buying: What to Look For	p32 May 85 No.8
Hardtop Fixings	p20 Apr 96 No.190		(Turning Circle)
Hardtops (Mk.IV/1500)	p22 Nov 89 No.113	Californian Spitfires	p60 Jun 03 No.276
Heritage Bonnets	p22 Sep 99 No.231	Classic Sports Racer (Spitfire)	p28 Mar 04 No.285
Panel Interchangeability(GT6)	p39 Mar 85 No.57	Climax Herald and Spitfire	p64 Jun 02 No.264
Panel Replacements	p18 Oct 93 No.160	Competition Spitfire	p18 Jul 88 No.97
Pop Up Headlights	p18 Dec 95 No.186	Concept Spitfires	p32 Feb 98 No.212
Rear Valances (Early)	p38 May 93 No.155	'Dynamo Digby' Spitfire	p78 Aug 00 No.242
Rear Wings Replacement	p17 Jan 82 No.19	Eagle Spitfire	p43 Jan 05 No.295
Sill Replacement	p43 Aug 85 No.62,	European Spitfires	p32 Oct 04 No.292
	p22 Feb 86 No.68	FD75000 and Beyond	p10 May 00 No.239
Sill and Floor Replacement	p18 Jul 97 No.205	First Sports Car	p62 Nov 04 No.293
Targa Top	p64 Jan 98 No.211	1500 Spitfires Body Guide	p27 Oct 89 No.112
Weatherproofing	p30 Jan 04 No.283	1500 Profile	p67 Feb 89 No.104,
Wheel Arch Repair	p45 Jul 85 No.61		p38 May 89 No.107
		First Production Spitfire	p42 Oct 01 No.256
Brakes:		40 Glorious Years	p58 Jul 02 No.265
Brakes.....	p32 Dec 90 No.126,	412 VC (early anomalies)	p22 Apr 00 No.238
	p29 Feb 91 No.126,	HAR 669G: Everyday Transport	p60 Dec 00 No.246,
	p39 Mar 91 No.129		p14 Jan 01 No.247
Brakes and Suspension (Uprated)	p10 Dec 99 No.234,	Historic Racing Spitfire	p51 Mar 91 No.123
	p42 Feb 00 No.236	History 1974 - 80	p20 Aug 82 No.26
Brake Pipes	p41 Jun 88 No.96,	Know Your Spitfire	p32 Jan 91 No.127,
	p45 Sep 88 No.99		p29 Feb 91 No.128
Brake Servo Fitting	p28 Aug 99 No.230	Le Mans Spitfire	p75 Sep 90 No.123
Brake Warning Light	p59 Feb 89 No.104	Life with a Spitfire	p57 Nov 04 No.293
"Disc Concerting" Knock	p46 Dec 85 No.66	Lightweight Spitfire	p8 Nov 01 No.257
Rear Brake Hose	p38 Sep 94 No.171	Macau Replica	p57 Mar 91 No.129
		Macau Spitfire	p62 Dec 89 No.114,
Carburettors:			p69 Aug 01 No.254
Air Filter Box	p16 Nov 84 No.53	M G Midget, Honda S800 Comparison	p4 July '84 No.49
Carb Icing	p35 Mar 89 No.105	Mk.IV	p23 Mar 83 No.33
Fuel Vapourisation (1500)	p9 Feb 81 No.8	Mk.IV Indentifile	p42 July 00 No.241
Pancake Air Filters	p26 Feb 83 No.32,	MKIV Road Test	p42 Nov 97 No.209
	p46 Apr 83 No.34	Mk.3 Optional Extras	p29 Feb 84 No.44
Spitfire SU's	p25 May 90 No.119	Mk.3 Profile	p51 Oct 89 No.112,
SU Carbs	p20 Aug 01 No.254,		p63 Jan 90, No.115
	p20 Sep 01 No.255,	Mk.3 vs. MkIV/1500	p52 Oct 99 No.232
	p5 Oct 01 No.256	Mk.2 and '3 Compared	p24 May 84 No.47
SU Carb Tune	p27 Mar 92 No.141	Mk.2 Concours	p75 Aug 90 No.122
SU or Stromberg?	p61 Jun 04 No.288	Michigan Style Spitfire	p78 Feb 02 No.260
Twin Strombergs	p16 Jan 97 No.199	Model Review	p39 Apr 85 No.58
Waxstats	p55 Mar 86 No.69,	Modified 1500	p73 Apr 85 No.58
	p18 Aug 87 No.86,	Moving On IV and 1500	p3 May 85 No.8
	p27 Oct 87 No.88,		(Turning Circle)
	p65 Aug 96 No.194,	New Spitfire (archive)	p63 Jul 97 No.205



Item	Page & Issue No.
Pre-production Model	p8 Nov 80 No.5
Racing Bullet-in	p56 Oct 00 No.24
Road Car or Race Car? Tigger	p68 Jul 05 No.301, p32 Oct 05 No.304
Spitfire Evolution	p38 Mar 00 No.237, p38 Apr 00 No.238, p38 May 00 No.239
Spitfire 4	p17 Sep 87 No.87
Spitfire 4 Cutaway	p34 Aug 88 No.98
Spitfire 4 Mk.2	p23 Nov 87 No.89
Spitfire MkIV Cutaway	p34 Sep 88 No.99
Spitfire Mk.3	p29 Dec 87 No.90
Spitfire '6'	p42 Aug 87 No.86
Spitfire versus MG	p32 Mar 99 No.225, p41 Apr 99 No.226
Spitford?	p48 May 88 No.95
Sprintfire	p51 Feb 94 No.164
Sprinzl Conversion	p26 Mar 96 No.189
Triumph Spitfire by Michelotti	p70 Oct 98 No.220
TR Spitfire	p24 Jul 82 No.25
Two-Litre Convertible	p21 Jun 90 No.120
US Federal Spec.1500	p35 Feb 96 No.188
USA Spitfires (under the bonnet)	p29 Apr 90 No.130, p26 May 91 No.131, p29 Jun 91 No.132
Versus The MG Midget	p20 Jan.83 No.31
Very Last Spitfire	p32 Mar 01 No.249
Works Spitfire Stage 2 1147cc	p47 Nov 85 No.65

Cooling System:

Cooling Fan	p40 Mar 88 No.93
Cooling System	p17 Jan 86 No.67, p27 Jul 90 No.121 p31 Apr 96 No.190
Oil Cooler	p34 Jun 83 No.36
Overheating Tips	p67 Sep 93 No.159, p60 Oct 93 No.160, p63 Nov 93 No.161, p46 Dec 93 No.162, p74 Feb 94 No.164, p78 Apr 94 No.166
Radiators	p31 Sep 95 No.183, p49 Nov 95 No.185
Viscous Fan Fitting	p37 Jul 83 No.37

Distributors:

Distributors	p12 Jan 84 No.43, p30 Oct 90 No.124
Distributor Tips	p12 Apr 00 No.238
Rotor Arms	p38 May 03 No.275

Electrical:

Ballast Resistor Failure	p48 Dec 93 No.162
Chafing Wire	p48 Feb 93 No.152
Electric Fan Conversion (Metro-Spitfire)	p40 Aug 01 No.254
Fog Light Fitting	p39 Apr 91 No.130
Fuse Box Alert	p59 Jan 91 No.127
Fuse Box Tips	p51 Feb 05 No.296
Instrumentation/Gauges	p27 Sep 90 No.123,

Item	Page & Issue No.
Night Dimming Relay	p25 Jan 91 No.127, p52 Mar 91 No.129 p8 May 85 No.8 (Turning Circle), p36 Feb 89 No.104, p48 Apr 89 No.106
Radio Fitting	p58 May 90 No.119
Steering Column Switchgear	p20 Sep 87 No.87
Winter Lights	p30 Nov 94 No.173

Engine/Ancillaries:

Alfa Twin Cam	p23 Jan 91 No.127
Aluminium Head	p15 Mar 00 No.237
A New Engine is Born	p31 Dec 94 No.174, p29 Jan 95 No.175, p30 Feb 95 No.176, p26 Mar 95 No.177
Backplate/Clutch Tip	p40 Aug 85 No.62
BHP for Pennies	p74 Mar 91 No.129
Bottom End Rebuild	p31 Sep 94 No.171
Cambelt Kit?	p47 Jun 04 No.288
Cam Follower Fault	p46 Jul 83 No.37
Crankshaft Pulley Key Fault	p29 Sept 83 No.39
Cylinder Head Modifications	p31 Oct 93 No.160, p30 Nov 93 No.161, p31 Dec 93 No.162
Dolomite Engine	p34 Mar 84 No.45
Dynamo Brackets	p38 Nov 93 No.161
Electric Water Pump Fitting	p36 Jul 03 No.277
Emission Control	p31 Mar 91 No.129
Engine Bays (MkIV/1500)	p32 Aug 93 No.158
Engine: Interchangeable Parts	p38 Aug 00 No.242
Engine out/in	p22 Dec 96 No.198
Engine Prefixes	p10 Jul 05 No.301
Engine Spares	p50 Oct 90 No.124
Engine Spec. Changes	p16 Jan 84 No.43
Engine Transplant	p28 Oct 00 No.244
Engine Tuning (Stage 1)	p25 Jan 87 No.79
Engine Upgrading	p54 Mar 02 No.261
Fuel Injection	p29 Jul 84 No.49
Head Work	p26 Apr 97 No.202, p19, 53 May 97
No.203 Improved Lubrication	p17 Mar 84 No.46
Inlet Manifolds	p6 Apr 99 No.226
Matching Oil Pressure Gauge	p41,43 Dec 83 No.42
Mid Engine Spitfire?	p24 Apr 89 No.106, p6 May 89 No.107
Misfire (coil)	p40 Jul 83 No.37
Mk.I, 'II, 'III Engines	p33 Sep 92 No.147, p42 Oct 92 No.148
Oil Change Tip	p40 Aug85 Nc.62
Oil Cooler	p34 Jun 83 No.36
Rocker Cover Emulsion	p30 Jun 84 No.48
SC Engine Development	p68 Nov 05 No.305
Silencer Construction (Mk.IV)	p10 Sep 85 No.63
Spark Plug Equivalents	p35 Aug 83 No.38
Spitfire Power	p32 Aug 94 No.170, p35 Sep 94 No.171, p70 Nov 94 No.173,

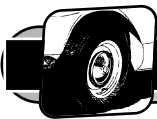

SPITFIRE

Item	Page & Issue No.
.....	p35 Dec 94 No.174
Supercharger	p46 Oct 90 No.124, p63 Apr 91 No.130
1300 Head Gaskets	p70 May 90 No.119
Timing	p14 Feb 83 No.32, p31 Apr 83 No.34
Twin Cam Spitfire	p33 Jul 95 No.181
2-litre Installations	p18 Sept 83 No.39, p30 Nov 83 No.41, p29 Feb 84 No.44, p29 Mar 84 No.45
Valve Adjustment	p39 Mar 86 No.69

Exhaust Systems:

Exhaust Diagrams	p15 Jul 01 No.253
Exhausts	p9,15 Dec 88 No.102
Exhaust Manifolds	p30 Jul 91 No.133, p33 Aug 91 No.134
Fiat 1600 DOHC (Spitfire Transplant?)	p66 Jun 89 No.108
1500 Exhaust Manifold/Downpipe Gasket	p18,29 Aug 87 No.86, p52 Sep 87 No.87, p46 Oct 87 No.88, p32 Jan 88 No.91
1500 Exhaust System	p57 Jul 88 No.97

General/Miscellaneous:

Accessories	p39 Nov 94 No.173
ADU 4B Pictorial Archive	p52 Dec 97 No.210
Articles Review Mk.IV/1500	p26 Oct 94 No.172
Bass Guitar Rack	p32 Nov 99 No.233
Buying Check	p39 May 90 No.119, p31 Jun 90 No.120
Chassis/Commission Numbers	p50 Oct 90 No.124, p32 Feb 94 No.164, p26 May 94 No.167.
Crash Performance	p30 Apr 97 No.202
Concept Spitfires	p44 Jun 97 No.204, p32,78 Jul 97 No.205, p58 Sep 97 No.207, p31 Oct 97 No.208
Concours Tips	p23 Jul 90 No.121
Customising	p33 Mar 93 No.153, p32 May 93 No.155
Ergonomics	p27 Nov 90 No.125
Find that Part	p32 May 98 No.215
Fuel Tanks, Tips	p56 Mar 05 No.297, p32 Apr 05 No.298, p78 Aug 05 No.302
General Sorting Tips	p58 Apr 04 No.286
Hardtops, Heads and Heaters	p14 Apr 98 No.214
Homologation/Conversions	p18 Aug 97 No.206
Improving the Breed	p38 Aug 99 No.230, p40 Nov 99 No.233
Interchangeable Parts	p22 Mar 83 No.33
IVRs	p32 Mar 03 No.273, p39 May 03 No.275, p5 Sep 03 No.279, p49 Nov 03 No.281,

Item	Page & Issue No.
.....	p66 May 04 No.287, p44 Sep 04 No.291, p17 Dec 04 No.294, p26 Oct 05 No.304
Left Hand Drive Conversion	p32 Aug 91 No.134
Locking Petrol Cap	p15 Nov 84 No.53
Modify or Not?	p24 May 89 No.107, p62,64 Jun 89 No.108
MOT	p29 Mar 90 No.117
Number Plates	p36 Jul 84 No.49
Optional Extras	p27 Aug 90 No.122, p23 Sep 90 No.123
Parts Changes Mk.3	p40 Feb 02 No.260
Parts Changes Spitfire 4 / Mk.2	p64 Sep 01 No.255, p9 Nov 01 No.257
Parts Commonality	p26 Sep 91 No.135, p35 Oct 91 No.136, p30 Nov 91 No.137
Plastic Bonnets	p78 Apr 94 No.166
Prefixes and Suffixes	p30 Mar 05 No.297
Production Figures	p4 May 85 No.8 (Turning Circle)
SAH Stage Conversions	p28 Dec 96 No.198
Secure Stowage Space	p46 Nov 98 No.221
Service Check	p25 Jun 88 No.96, p38 Aug 89 No.110
Service Info.	p19 Sep 93 No.159
Service Instructions	p26 Jun 95 No.180
Service Tips	p30 Jun 97 No.204
Six Cylinder Spitfire	p35 Oct 84 No.52
Six Pot Spitfire	p14 Aug 99 No.230, p14 Oct 99 No.232, p41 Nov 99 No.233, p46 Apr 98 No.214, p36 May 02 No.263
Soup a Spitfire	p32 Nov 96 No.197
Special Tuning Spitfire	p38 Mar 95 No.177, p30 Jun 95 No.180
Spitfire Improvement	p38 Aug 99 No.230
Spitfires in Miniature	p62 Dec 02 No.270, p43 Feb 03 No.272
Spitfire 6 Power Boost (TR5 Head)	p16 Jun 03 No.276
Spitfire Tool Tray ?	p34 Aug 95 No.182
Spring Clean	p31 Apr 92 No.142
Steam Powered	p77 Feb 92 No.140
Tips and More Tips	p39 Sep 99 No.231, p38 Dec 99 No.234
Tool Kits and Literature	p27 Jul 93 No.157
Touring Preparation	p62 Dec 01 No.258
Tuning	p21 Apr 82 No.2 (Turning Circle) p30 Mar 84 No.45
Tuning (books)	p4 Dec 80 No.6, p5 Mar 81 No.9
Tuning Kits	p21 May 88 No.95, p18 Aug 97 No.206
Tuning on the Cheap	p19 Apr 88 No.94
Water Leaks	p15 Sept 98 No.219
Weather Proofing	p26 Mar 94 No.165,



Item	Page & Issue No.
.....	p8 Dec 98 No.222
What Value a Spitfire?	p38 July 99 No.229,
.....	p64 Aug 99 No.230
Wind Deflector	p50 Nov 05 No.305
Winter Tips	p35 Nov 89 No.113,
.....	p23 Jan 91 No.127

Mechanicals (Other):

Door Glass Remedy	p10 Mar 99 No.225
Door Handles - MkIV, 1500	p18 Aug 87 No.86
Door Locks	p15 Feb 83 No.32,
.....	p24 Dec 93 No.162
Handbrake Fettleing	p46 Mar 93 No.153
Heaters	p26 Dec 97 No.210
Heater Tip	p24 Feb 86 No.68,
.....	p18 Nov 92 No.149
Single Carb Spitfire	p22 Nov 98 No.221
SixPots	p62 Jan 99 No.223,
.....	p49 Feb 99 No.224,
.....	p32 May 99 No.227,
.....	p32 Jun 99 No.228,
.....	p14 Aug 99 No.230,
.....	p14 Oct 99 No.232,
.....	p41 Nov 99 No.233
Steering Collumn Lock (Early Cars)	p35 Oct 94 No.172
Window Regulators	p18 Jul 93 No.157
Window Winder Mechanism	p14 Mar 88 No.93
Windscreen Wiper, Wheel Boxes	p18 Jan 93 No.151

Paint:

Flamenco Red Paint?	p47 Jun 02 No.264
Mystery Colour	p29 Apr 97 No.202,
.....	p53 May 97 No.203
Paint Options	p23 Sep 91 No.135
Paint/Trim Codes	p30 Dec 83 No.42,
.....	p31 Jun 85 No.60,
.....	p47 Oct 90 No.124
Paint/Trim Codes - 1500	p70 Jun 89 No.108

Restoration/Rebuild Projects:

A Spitfire Saved	p74 Apr 00 No.238
Building a New Spitfire1500	p9 May 85 No.8
.....	(Turning Circle)
Club Restoration Project 1500	p5 Feb 93 No.152,
.....	p64 Mar 93 No.153,
.....	p63 Apr 93 No.154,
.....	p63 May 93 No.155,
.....	p70 Jun 93 No.156,
.....	p71 Jul 93 No.157,
.....	p70 Aug 93 No.158,
.....	p70 Sep 93 No.159,
.....	p70 Oct 93 No.160,
.....	Nov 93 No.161,
.....	p70 Dec 93 No.162,
.....	p70 Jan 94 No.163
1500 Restoration DAO 328T	p54 Feb 01 No. 248,
.....	p53 Mar 01 No.249
Gremlin Restoration (Mk.1)	p16 Jun 02 No.264
Jenny's Story (Part2)	p52 July 98 No.217

Item	Page & Issue No.
-------------	-----------------------------

Le Mans Spitfire Under Restoration	p52 Jun 01 No.252
Maria's Story UYD 888W	p46 Jun 01 No.252
MBH 770L	p28 Sep 02 No.267
MK IV Rebuild	p11 Feb 81 No.8,
.....	p15 Apr 81 No.10
Mk.3 Restoration	p70 Feb 91 No.128
Oily Fingers Restoration (Mk.3)	p74 Oct 92 No.148
Project Spitfire 'OSW'	p32 Jul 96 No.193,
.....	p28 Nov 96 No.197,
.....	p22 Dec 96 No.198,
.....	p49 Jan 97 No.199,
.....	p30 Sep 97 No.207,
.....	p68 Mar 98 No.213,
.....	p52 May 98 No.215,
.....	p38 Dec 00 No.246
Quadrio Concours Rebuild	p28 Feb 00 No.236,
.....	p52 Mar 00 No.237
Rebuilding a Spitfire	p30 Apr 82 No.2
.....	(Turning Circle)
Rebuilding the Bullet	p60 Aug 04 No.290
Rebuild 'Nelly' GNG 295N	p38 Dec 88 No.102
Restoration LFF 493J	p74 Oct 94 No.172,
.....	p14 Apr 95 No.178
Restoration UBB 117G	p42 Feb 99 No.224,
.....	p66 Mar 99 No.225,
.....	p74 Apr 99 No.226,
.....	p64 May 99 No.227,
.....	p74 Jun 99 No.228
Second Time Around	p76 Apr 02 No.262
Spitfire/GT6 Project	p57 May 89 No.107
Spitfire Saved	p74 Apr 00 No.238
TFU 868H Restoration	p60 Dec 03 No.282
XPD 331Y	p22 Aug 02 No.266
YAX 445J Mk.3 Rebuild	p39 Apr 01 No.250

Suspension and Steering:

Early Rear Suspension	p22 Apr 92 No.142
Fitting a Roll Bar	p9 Jun 81 No.12
Front Suspension	p18 Mar 92 No.141
Front Suspension & Brake Interchangeability	p23 May 85 No.59.
Front Trunnion Replacement	p29 Aug 86 No.74
Improved Roadholding Tips	p25 Jan 87 No.79
Rear Anti Roll Bar- Mk.IV, 1500	p56 Jun 89 No.108,
.....	p45 Jul 89 No.109
Rear Spring Replacement	p18 Feb. 82 No.20,
.....	p72 Dec 89 No.114
Rear Springs	p27 Sep 92 No.147,
.....	p33 Oct 92 No.148,
.....	p31 Nov 92 No.149,
.....	p45 Dec 04 No.294
Rear Suspension Racing Mod. p.	13 Jul 86 No.73
Spring Time (shock absorbers)	p14 May 85 No.8
.....	(Turning Circle)
Steering	p27 Aug 92 No.146
Steering Racks	p22 May 92 No.143,
.....	p58 Jul 04 No.289
Suspension Set-Ups	p4 Feb 86 No.68,

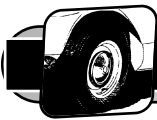

SPITFIRE

<u>Item</u>	<u>Page & Issue No.</u>
.....	p46 Mar 86 No.69,
.....	p37 Apr 86 No.70
Suspension Strip	p74 Aug 93 No.158,
.....	p70 Sep 93 No.159,
.....	p70 Oct 93 No.160,
.....	p70 Nov 93 No.161
Suspension Torque	p77 Jun 95 No.180
Suspension Upgrade?	p12 Apr 00 No.238
Swing Spring Sag	p27 May 94 No.167

Transmission:

Clutch Compatibility -1500/1300	p19 Mar 94 No.165
Clutch Problems	p31 Aug 92 No.146,
.....	p50 Sep 05 No.303
Clutch Replacement	p24 Dec 84 No.54,
.....	p53 Apr 95 No.178,
.....	p53 May 95 No.179,
.....	p74 Oct 96 No.196
Driveshafts	p48 Oct 04 No.292
1500 Clutch Judder	p64 Oct 91 No.136
1500 Single Rail Gearbox Reconditioning	
.....	p49 Jul 89 No.109,
.....	p45 Aug 89 No.110,
.....	p55 Sep 89 No.111,
.....	p41 Oct 89 No.112
Front Hubs	p32 Mar 84 No.45,
.....	p30 Jun 84 No.48
Front Wheel Bearing Replacement	p75 Mar 90 No.117
Gearboxes	p15 May 83 No.35
Gearboxes and Clutches	p34 Dec 02 No.270
Gearboxes and Propshafts	p45 Jan 88 No.91
Gearbox Fumblings	p18 Aug 98 No.218
Gearbox Fun	p19 Apr 82 No.2
	(Turning Circle)
Gearbox Uprating	p75 Jun 05 No.300
Gear Lever Extension	p41 Aug 01 No.254
Overdrive	p32 Apr 83 No.34,
.....	p36 Oct 84 No.52
Overdrive Gearboxes - Mk.IV/1500	p33 Feb 92 No.140
Rear Axle	p14 Oct 82 No.28
Rear Hubs	p23 Apr 90 No.118
Rotoflex Conversion	p66 Oct 91 No.136
UJ Examination	p18 Sept 83 No.39
Wrong Roll Bar	p30 Nov 82 No.29

Trim:

Badging	p22 May 85 No.59
---------	------------------

<u>Item</u>	<u>Page & Issue No.</u>
Boot Trim - Mk.IV/1500	p33 Aug 89 No.110
Carpets	p39 Jul 96 No.193,
.....	p10 Apr 99 No.226
Carpet Fitting	p29 Aug 90 No.122
Dashboard Veneering	p28 Jun 99 No.228
Decals/Badges	p37 Jul 83 No.37
Grill Replacement	p74 Nov 99 No.233
Hood Fitting	p58 Mar 92 No.141,
.....	p71 Apr 92 No.142,
.....	p58 May 92 No.143,
.....	p68 Nov 02 No.269
Hood Folding	p36 Jul 88 No.97,
.....	p11 Sep 88 No.99
Hood Folding	p14 Sep 97 No.207
Interiors Guide - 1500	p27 Sep 89 No.111
Paint/Trim Codes	p30 Dec 83 No.42,
.....	p31 Jun 85 No.60,
.....	p47 Oct 90 No.124
Paint/Trim Codes - 1500	p70 Jun 89 No.108
Rear Seat	p26 May 95 No.179,
.....	p14 Jul 95 No.181,
.....	p8 Jan 96 No.187
Rear Seats?	p8 Mar 99 No.225
Rear Wing Trim	p43 Apr 01 No.250
Seat Re-Covering	p28 Nov 97 No.209
Seat Renovation	p70 July 99 No.229
Seat Risers	p74 Apr 90 No.118,
.....	p66 Jun 90 No.120
Soft Top Folding Procedure	p32 Sept 83 No.39
Spitfire Seat	p38 Nov 99 No.233
Sunvisors	p18 Dec 94 No.174

Wheels and Tyres:

Alloy Wheel Options	p10 Jun 00 No.240
Dolomite Wheels?	p10 Apr 00 No.238
Tyres and Wheels	p31 Jul 92 No.145,
.....	p32 Aug 92 No.146
Tyres Explained	p54 Nov 05 No.305
Tyre Pressures Mk.IV/1500	p36 Feb 89 No.104
Wheel Colour	p14 Jun 02 No.264
Wheel Slot Width	p15 Jun 02 No.264
Wire Wheels	p30 Nov 85 No.65,
.....	p30 Feb 90 No.116,
.....	p31 Dec 92 No.150,
.....	p41 Sep 05 No.303

STAG



<u>Item</u>	<u>Page & Issue No.</u>
Stag	
Diff Replacement	p34 Jul 05 No.301
General Intro/Profile	p26 Jun 03 No.276
Impressions of a Stag	p78 Feb 03 No.272
IVRs	p34 Jul 05 No.301,

<u>Item</u>	<u>Page & Issue No.</u>
.....	p81 Oct 05 No.304
Memories of a Stag	p72 Dec 02 No.270
STJ 5M	p33 Feb 04 No.284
Track Day Stag	p36 Dec 03 No.282
Wheel Restoration	p62 May 04 No.287

TOLEDO/DOLOMITE 1300/1500



Item **Page & Issue No.**
Toledo/Dolomite/1300/1500

Dolly Sunshine Road Fitting? p48 Mar 05 No.297
 Dolomite 1300/1500 p30 Sep 05 No.303
 IVR p30 Dec 04 No.294,
 p79 Jun 05 No.300

Item **Page & Issue No.**
 Models p34 Jun 05 No.300
 Small Saloon range p55 Apr 04 No.286,
 p30 May 04 No.287
 1300 FWD p48 Feb 05 No.296
 Toledo p49 Aug 04 No.290

TR



Item **Page & Issue No.**
TR

Exhaust Manifold Design p76 Jul 05 No.301,
 p10 Aug 05 No.302
 Fuel Injection Puzzler p38 Sep 05 No.303
 Gear Selection Sorted p46 Jun 05 No.300
 Oil Distribution at High RPM p64 Oct 05 No.304
 TR5 Restoration p74 Feb 04 No.284,

Item **Page & Issue No.**
 p72 Mar 04 No.285,
 p64 Apr 04 No.286,
 p76 May 04 No.287,
 p77 Jun 04 No.288,
 p76 Jul 04 No.289
 TR Technical p78 Dec 02 No.270,
 p78 Jan 03 No.271
 TR250 Tuning p58 Nov 05 No.305

2000/2500/2.5PI



Item **Page & Issue No.**
2000/2500/2.5PI

Code Numbers p56 Jan 05 No.295
 Flossie p25 Jul 03 No.277

Item **Page & Issue No.**
 IVRs p21,81 Aug 05 No.302
 Origins of 'Barb' p54 Oct 03 No.280
 2.5PI Appreciation p27 Jul 03 No.277
 2000 and GT6 Gearboxes p79 Aug 00 No.242

VITESSE



Item **Page & Issue No.**
Vitesse

Bodywork/Chassis:
 Body Fitment p11 Dec 95 No.186,
 p11 Jan 96 No.187,
 p29 Feb 96 No.188
 Body Fitting p51 Dec 92 No.150
 Body Lift p77 Sep 92 No.147
 Body Mounting Bracket Replacement p51 Dec 91 No.138
 Body Numbering p40 Mar 03 No.273
 Body Removal p18 Sept 83 No.39
 Body Removal p51 Sep 91 No.135,
 p47 May 92 No.143
 Bonnet Bracket Extentions p29 Apr 87 No.82
 Bonnet Conversion 13/60 to Vitesse p51 Feb 92 No.140
 Boot Panel Restoration p10 Nov 80 No.5
 Chassis Dimensions p21 May 90 No.119
 Chassis Repairs p51 Oct 91 No.133,
 p51 Nov 91 No.137
 Chassis Woes p68 Oct 95 No.184

Item **Page & Issue No.**
 Door Fitting Training Notes p46 Dec 01 No.258,
 p26 Jan 02 No.259,
 p37 Feb 02 No.260,
 p27 Mar 02 No.261,
 p57 Apr 02 No.262,
 p26 May 02 No.263
 Door Reskinning p51 Apr 89 No.106
 Extended Convertible p30 Aug 82 No.26
 Fitting Up Your Body p24 Feb 85 No.56,
 p34 Jun 85 No.60
 Floor Pan Repair p14 Aug 93 No.158
 Front Valence Repair p24 May 87 No.83
 Hardtop p23 Nov 82 No.29
 Hardtop Revisited p5 Feb 86 No.68
 Outriggers p23 Mar 82 No.21
 Outriggers Tips p73 Dec 89 No.114
 Rear Body Tub Repairs p51 Jan 92 No.139
 Rear Wing Replacement p51 Jul 91 No.133,
 p51 Aug 91 No.134
 Saloon Roof Removal p23 Aug 89 No.110



VITESSE

Item	Page & Issue No.
Seat Belt Mounting Point Repair	p28 Dec 97 No.210
1600 Chassis Plate	p66 Jun 03 No.276
Sticky Windows Cure	p16 Jan 98 No.211

Brakes:

Brake Pads	p15 Jul 92 No.145, p24 Nov 05 No.305
Brake Servo Positions	p14 Jan 99 No.223, p40 Mar 99 No.225, p30 May 99 No.227
Brake Upgrading Conversion	p53 Mar 90 No.117, p77 Apr 90 No.118
Handbrake Check	p27 Nov 85 No.9 (Turning Circle)
Brake/Suspension Parts	p24 Mar 84 No.45
Handbrake Cable Replacement	p22 Oct 80 No.4 Odd
Calipers	p34 Oct 82 No.3 (Turning Circle)

Carburettors:

Amal Carbs / Manifolds	p75 Aug 03 No.278
Carb Choice DVT 784J	p4 Feb 89 No.104
Carburettors	p29 Sep 93 No.159
Carburettor Conversion Problem	p41 Feb 85 No.56
HS6 Carb Fitting	p34 Apr 87 No.82

Car Profiles/Buying:

Acclaim to Fame	p56 Jan 03 No.271, p66 Feb 03 No.272
Advert Differences	p32 Jan 01 No.247
Allesley Collection	p72 Apr 03 No.274
Amphicar Register	p14 May 02 No.263
Australian Roundup	p52 July 00 No.241
Automatic Vitesse	p48 May 92 No.143
Blue Peter Triumphs	p74 Mar 03 No.273
Buying Guide	p52 Sept 90 No.123
Concept Vitesse	p42 Oct 97 No.208
Contemporary Cars	p14 Mar 05 No.297
Coupe?	p38 Oct 89 No.112, p64 Nov 01 No.257
Estate	p17 Mar 82 No.21, p54 Oct 82 No.3 (Turning Circle)
Estates	p18 Aug 89 No.110, p37 Oct 89 No.112, p22 July 00 No.241, p74 Sep 00 No.243, p65 Nov 00 No.245
Flower Power	p46 Apr 01 No.250
Historic Rally Vitesse	p46 May 93 No.155, p66 Jun 93 No.156
HKG 650D	p54 July 00 No.241
Holland Import	p37 Feb 02 No.260
In Malaysia	p25 Oct 00 No.244
In New Zealand	p18 Aug 00 No.242, p14 Sep 00 No.243, p22 Oct 00 No.244
Last Four Vitesse	p44 Jul 01 No.253, p10 Aug 01 No.254

Item	Page & Issue No.
Last of the Line Reunion	p40 Mar 03 No.273
Leon's Timely Vitesse	p51 Aug 97 No.206, p70 Apr 98 No.214
Mk2 Convertible Profile	p63 Apr 90 No.118
Mk.2 vs. Crayford Convertible	p7 May 98 No.215
One Owner from New	p38 Sep 01 No.255, p28 Oct 01 No.256
Originality Guide	p28 Oct 86 No.76
Press Car Memories	p68 Jun 02 No.264
1600 Cutaway	p38 Apr 89 No.106
Thirty Years of Triumph	p74 Dec 01 No.258
Tristan Conversion	p32 Apr 01 No.250
Triumph 1300 "Ajax"	p70 Feb 02 No.260
TRs	p68 Apr 02 No.262
Turkish Delight 'Otosan Anadol'	p58 Sep 00 No.243, p42 Oct 00 No.244
2.5 Pl Vitesse	p28 Oct 82 No.3 (Turning Circle), p29 Nov 82 No.29
Vitesse 6 Saloon Profile	p75 Feb 90 No.116
Vitesse Estates	p24 Feb 89 No.104, p30 Jun 89 No.108, p22 July 00 No.241
Vitesse Mk.2 (Autocar)	p56 Oct 82 No.3 (Turning Circle)
Vitesse or Herald Vanden Plas?	p35 Apr 90 No.118
Vitesse Six (Motor)	p3 Oct 82 No.3 (Turning Circle)

Cooling System:

Heater Overhaul	p66 Mar 96 No.189
Heater Upgrading	p39 Mar 93 No.153
Radiators	p71 Aug 90 No.122
Water Pumps	p24 Jul 05 No.301

Electrical:

Alternator Fitting	p26 Feb 04 No.284
Heated Rear Window	p33 Oct 01 No.256, p44 Dec 01 No.258
Ignition Fault Found	p44 Aug 04 No.290
Radio Installation	p15 Jan 99 No.223
Radiomobile Radio	p26 Jul 04 No.289
Voltage Regulator: Suitable/Replacement	p14 Oct 80 No.4, p17 Dec 80 No.6
Washer/Wiper Switches	p15 Aug 94 No.170
Wiper Assemblies	p38 Oct 94 No.172

Engine/Ancillaries:

Backfire	p17 Mar 84 No.45
Choke Cable Joint	p24 May 95 No.179
Crankshaft Changes	p25 Mar 84 No.45
Crankshaft Pulley Bolt Removal	p17 May 89 No.107
Cylinder Head Replacement	p17 Oct. 81 No.16
Cylinder Head Tip	p53 Dec 95 No.186
Engine Prefixes	p29 Apr 95 No.178
Flywheels	p12 Jun 86 No.72
Hot/Cold Inlet Manifolds	p34 May 89 No.107
Inlet Manifolds	p24 Sep 89 No.111,



Item	Page & Issue No.	Item	Page & Issue No.
Modified 2-Litre Engines	p19 Oct 89 No.112 p9 Nov 85 No.9 (Turning Circle)		p28 Jul 97 No.205, p54 Sep 97 No.207, p20 Nov 97 No.209, p18 Jan 98 No.211, p15 Mar 98 No.213, p38 May 98 No.215, p62 Nov 00 No.245, p14 Mar 01 No.249, p44 Jul 01 No.253, p60 Nov 01 No.257, p22 Mar 02 No.261, p62 Sep 02 No.267, p54 Nov 02 No.269, p54 Jan 03 No.271, p38 Mar 03 No.273, p55 Jul 03 No.277, p40 Oct 03 No.280, p58 Dec 03 No.282, p28 Jan 04 No.283, p42 Jul 04 No.289, p16 Nov 04 No.293, p38 May 05 No.299, p81 Nov 05 No.305
Modified 2.5 PI Engine	p21 Oct 81 No.16	Leak Sorting	p21 Mar 89 No.105
Octane Booster	p26 Sept 83 No.39	Lubrication and Maintenance	p22 Mar 97 No.201
Oil Filter Adaptor	p53 Dec 95 No.186	Optional Extras	p14 May 98 No.215
Pinking Tips	p73 Dec 89 No.114	Owners Handbook Supplement	p48 May 01 No.251
Rocker Oil Feed	p40 Feb 01 No. 248, p34 Apr 01 No.250	Paint/Trim Colours	p58 July 99 No.229
Running On	p51 Mar 90 No.117	Peking to Paris Preparation	p65 Oct 97 No.208, p54 Nov 97 No.209
1600 Overbore	p23 May 90 No.119	Performance Figures	p4 Sept 83 No.39, p28 Oct 83 No.40
1600 Pistons	p14 Mar 90 No.117	Performance Table Comparison	p19 Nov 85 No.65
Spin On Oil Filter	p18 Feb 05 No.296	Period Magazine Ads	p58 Jan 04 No.283
2500 Engine Installation	p17 Mar 84 No.45	Press Packs	p72 Jul 03 No.277
Throttle Linkage	p28 May 97 No.203	Production Figures Mk2	p27 Oct 88 No.100, p23 Feb 89 No.104
Tuning of a 6-Cylinder Vitesse Engine	p48 Oct 82 No.3	SAH Performance	p37 Oct 89 No.112
(Turning Circle) Turbo Vitesse??	p30 Sept 83 No.39	Saloon to Convertible Conversion	p25 Apr 88 No.94
Turbocharged	p54 Mar 88 No.93	Saloon to Convertible Conversion	p28 Aug 82 No.26
Two Litre Tuning	p42 Mar 85 No.57, p43 Apr 85 No.58	Seatbelts	p68 Mar 96 No.189
Vitesse 6 Valve Guides	p42 Mar 85 No.57	Servicing Schedules	p48 Nov 02 No.269
Vitesse Engine Rebuild	p4 Nov 85 No.9 (Turning Circle)	Spares Suggestions	p38 Mar 04 No.285
		Spirit of Adventure (Preparation)	p31 Nov 98 No.221, p52 Feb 99 No.224
		Spirit of Adventure (General)	p22 Oct 98 No.220, p31 Nov 98 No.221, p18 Dec 98 No.222, p52 Feb 99 No.224, p52 Mar 99 No.225, p51 Apr 99 No.226, p51 May 99 No.227, p51 Jun 99 No.228
		Stanpart First Aid Kit	p49 Aug 03 No.278
		TR Technical	p78 Dec 02 No.270, p78 Jan 03 No.271
		Tracking Data	p35 Sep 96 No.195
		Tristan Convertible Kit	p7 Jul 92 No.145, p18,45 Oct 92 No.148
Exhaust Systems:			
Dual Silencer Kit SAH	p28 Sept 83 No.39, p37 Oct 83 No.40		
General/Miscellaneous:			
After Market Goodies	p20 Nov 02 No.269		
Archive Reports	p70 Sep 00 No.243, p32 Jan 01 No.247, p59 May 01 No.251, p56 Sep 01 No.255, p44 Jan 02 No.259, p48 Nov 02 No.269, p72 Jul 03 No.277, p40 Oct 03 No.280, p62 Dec 03 No.282, p44 Jan 04 No.283		
Archiving Service History	p62 Dec 03 No.282, p44 Jan 04 No.283		
Art of Driving a Motor Car	p21 Jul 01 No.253, p8 Aug 01 No.254, p30 Nov 01 No.257, p47 Dec 01 No.258		
Belisha Beacons	p30 Dec 00 No.246		
Convertible Waterproofing	p49 Apr 83 No.34		
Electric Vitesse?	p14 Apr 04 No.286		
Improved Heating	p25 Jan 83 No.31		
Institute of Advanced Motorists	p10 Aug 02 No.266, p7 Dec 01 No.258		
IVRs	p24 Sept 98 No.219, p16 Nov 98 No.221, p19 Jan 99 No.223, p70 Mar 99 No.225, p35 May 99 No.227, p57 July 99 No.229, p35 Sep 99 No.231, p14 Nov 99 No.233,		



VITESSE

Item	Page & Issue No.
.....	p70 May 93 No.155,
.....	p32 Apr 01 No.250
TSSC History	p38 Jan 01 No.247
Unleaded Fuel Use	p14 Jun 05 No.300,
.....	p80 Jul 05 No.301,
.....	p15 Sep 05 No.303
Vintage Ad.	p85 Oct 02 No.268,
.....	p85 Nov 02 No.269,
.....	p85 Dec 02 No.270
Vitesse as a Tow Car	p14 Oct 96 No.196
Vitesse in Motorsport	p80 Sep 97 No.207,
.....	p54 Oct 97 No.208
Web Bulletin Board Links	p76 Oct 00 No.244
Windscreen Codes	p60 Apr 93 No.154
Winter Storage?	p8 Apr 05 No.298

Mechanicals (Other):

Bonnet Locks	p36 Sep 91 No.135
Boot Hinge	p10 Oct 96 No.196
Door Lock Mod	p18 Jan 95 No.175
Passenger Side Door Lock	p18 Oct 91 No.136
Tow Bar Fitting	p31 July 98 No.217,
.....	p10 Sept 98 No.219

Paint:

Paint & Trim Combinations	p35 Jun 01 No.252
Touch Up Paints	p24 Nov 05 No.305

Restoration/Rebuild Projects:

Childhood Dream (restoration)	p70 Oct 99 No.232
Convertible Mk2 Reborn	p71 Jun 89 No.108
Convertible Reader's Restoration	p75 Nov 97 No.209
Mk.2 Convertible Restorations	p22 Jan 04 No.283,
.....	p34 May 04 No.287
Rebuild VAP 348H	p56 Jul 01 No.253,
.....	p54 Aug 01 No.254
Rebuilds and Index Marks	p38 Mar 01 No.249
Restoration (Vitesse 6)	p35 Feb 84 No.44,
Restorations	p12 Nov 04 No.293,
.....	p18 Feb 05 No.296
Rolling Chassis Rebuild	p51 Oct 92 No.148
The Restoration	p19 Nov 85 No.9
.....	(Turning Circle)
Thumper's Restoration	p7 Oct 82 No.3
.....	(Turning Circle)
Vitesse/Herald Restoration	p50 Feb 91 No.128,
.....	p63Mar 91 No.129,
.....	p51 Apr 91 No.130,
.....	p51 May 91 No.131,
.....	p51 all issues Jul 91
.....	No.133 to Jun 92
.....	No.144,
.....	p51 all issues Jul 92
.....	No.145 to May 93
.....	No.155 except p55
.....	Feb 93 No.152
Vitesse Restoration	p66 Feb 00 No.236,
.....	p55 Mar 00 No.237
UGT 720F Restoration	p66 Feb 00 No.236,

Item	Page & Issue No.
.....	p55 Mar 00 No.237
WCV 444J Restoration	p52 Jun 00 No.240
Wizard From OZ	p32 Aug 99 No.230
XJU 728J	p24 Jan 01 No.247,
.....	p5 Feb 01 No.248

Suspension and Steering:

Formula Steering Wheel	p39 Mar 04 No.285
Handling Improvement	p24 Sep 84 No.51
Lever Arm Dampers	p12 Aug 94 No.170
Rear Suspension Conversion to Telescopic
.....	p6 Mar, 81 No.9
Rear Suspension Spring lowering	p9 Aug 80 No.2 1600
Mk1 Suspension Geometry	p25 July 89 No.109
Suspension/Brake Parts	p24 Mar 84 No.45
Swing, Flex or Compensate	p18 Nov 03 No.281

Towing:

Trailers	p46 Dec 03 No.282
----------	-------------------

Transmission:

Choosing the Right Gearing	p26 Nov 85 No.9
(Turning Circle) Differential Replacements
.....	p31 Nov 82 No.29,
.....	p29 Jan 83 No.31
Dolomite Sprint Gearbox Overdrive Gearbox Swap	p24 Sep 84 No.51
Gearbox Conversion Tips	p23 Dec 84 No.54
Halfshaft UJ Replacement (Rubber Doughnut)
.....	p7 May 86 No.71
Mk.2 Clutch Slip	p70 May 90 No.119
Overdrive Conversion	p29 Jan 92 No.139
Overdrive Mounting Bracket	p42 Apr 83 No.34
Overdrive Propshaft	p35 Sep 96 No.195
Rear End Clonk	p23 Sept 82 No.27
Rotoflex Renewal	p61 Oct 82 No.3
Transmission Loads	p9 Jul 81 No.13
Welded Driveshaft	p12 Oct 95 No.184
Worn UJs	p20 Dec 80 No.6,
.....	p12 Mar 81 No.9

Trim:

Body Trim Options Mk.2	p54 May 88 No.95
Centre Console	p22 Jul 96 No.193,
.....	p28 Jan 97 No.199
Convertible Hood Folding	p38 Jul 88 No.97,
.....	p11 Sep 88 No.99
Convertible Seat Warning	p29 Jan 85 No.55
Dash Swap	p33 Dec 82 No.30
Dashboard/Door Cappings Renovation	p44 Jan 86 No.67,
.....	p32 Mar 86 No.69
Door Capping Renovation	p38 Aug 91 No.134
Door Glass Seals	p12 Jul 94 No.169
Doorseal Substitute	p55 Jun 89 No.108
Estate Sunroof	p15 Feb 00 No.236
Headlining Replacement	p51 Mar 93 No.153
Mudflaps	p19 Dec 92 No.150
Seat Upholstery Recovering	p51 May 92 No.143,
.....	p51 Jun 92 No.144
1600 Chassis Plate	p66 Jun 03 No.276
Soft Top Fitting	p51 Apr 53 No.154



Item

Tonneau Cover Support p25 Mar 90 No.117

Wheels and Tyres:

Wheel Trims..... p38,70 May 91 No.131

Page & Issue No.

Item

..... p23 Jun 91 No.132
Wire Wheel Fitting p23 Jul 88 No.97

Page & Issue No.

TECHNICAL (all models)

Item

Page & Issue No.

Technical All Models

Bodywork/Chassis:

Air Dam (Spitfire) p62 May 01 No.251
Ashley Hardtop p76 Jul 01 No.253,
..... p40 Aug 01 No.254,
..... p73 Sep 01 No.255
..... p70 Jan 02 No.259
Baby/Child Seats p79 Oct 00 No.244,
..... p9 Nov 00 No.245,
..... p8 Dec 00 No.246
Body Fitting Tweaks (Herald/Vitesse) p76 Nov 00 No.245
Body Fitment (Herald/Vitesse) ... p11 Dec 95 No.186,
..... p11 Jan 96 No.187,
..... p29 Feb 96 No.188
Bodywork/Finishing Kit Thoughts p64 May 04 No.287
Body Preparation/Paint p22 Jan 98 No.211,
..... p46,61 Mar 98 No.213
Body Repair Tips p10 Dec 97 No.210
Body to (Spitfire/GT6) p71 Nov 00 No.245,
..... p62 Oct 03 No.280
Bonnet Struts p65 Aug 94 No.170
Bulkhead Rubber Boots p75 Jun 05 No.300,
..... p80 Jul 05 No.301
Bumper Bolts (GT6 Mk1) p18 Jul 05 No.301
Bumper Raising (Spitfire) p59 Jan 04 No.283
Chassis Rigidity Increased p58 Mar 96 No.189
Chassis Torsional Stiffness p54 Mar 03 No.273
Composite Doors (GT6) p24 Mar 05 No.297
Convertible Comfort (Window Glass) p72 Dec 89 No.114
Corrosion Check Points (Spitfire) p58 May 04 No.287
Door Fitting Tip (Spitfire/GT6) ... p47 Mar 01 No.249,
..... p16 Aug 05 No.302
Door Gap Adjusting p72 Mar 03 No.273
Doors and Sills p40 May 01 No.251,
..... p68 Nov 02 No.269
Doorskin Replacement: (Herald/Vitesse) p51 Apr 89 No.106
Hardtop Fitting (Spitfire) p54 Nov 03 No.281
Heel Panel Fault? (GT6) p47 Nov 99 No.233
Hood Fitting p70 Feb 01 No. 248
Improvised Hardtops? (Herald/Vitesse) p50 Mar 05 No.297,
..... p44 May 05 No.299
Leak Sorting (Herald/Vitesse) p21 Mar 89 No.105
Le Mans Style GRP Bodyshell p66 Jan 04 No.283
Louvre Fitting (GT6) p44 May 04 No.287
Mk1 Chassis Weakness (Herald) ... p28 Jul 05 No.301
Outrigger Repairs (Herald) p48 May 04 No.287
Panel Gap Setting (Herald) p14 Aug 03 No.278
Roof repair (GT6) p44 Oct 86 No.76

Item

Page & Issue No.

Rust Killing p54 Apr 03 No.274
..... p74 May 03 No.275
Rustproofing Tip p24 Mar 87 No.81
Seat Belt Mounting Point Repair p28 Dec 97 No.210
Sill and Floor Replacement - Spitfire/GT6
..... p18 Jul 97 No.205,
..... p61 Jan 01 No.247
Sill Replacement - Spitfire/GT6 ... p43 Aug 85 No.62,
..... p22 Feb 86 No.68
Wheelarch Seal Mod p10 Feb 92 No.140
Window Stick Cure p16 Jan 98 No.211
Wing Louvres p14 Feb 04 No.284

Brakes:

Anti-Lock Brakes? p62 Dec 91 No.138
Bent Backplates p15 Oct 94 No.172,
..... p14 Nov 94 No.173,
..... p23 Dec 94 No.174
Brake Adjuster service p27 Jul 97 No.205
Brake Bleeding p47 Sep 88 No.99
Brake Calipers p51 Apr 92 No.142
Brake Caliper Strip p51 Jun 95 No.180
Brake Cylinder Seals p57 Sep 00 No.243
Brake Disc Rattle p51 Dec 88 No.102,
..... p58 Feb 89 No.104,
..... p48 Apr 89 No.106
Brake Faults p30 Aug 96 No.194
Brake Fluid Check p44 Jun No.132
Brake Improvements/Uprating ... p31 Oct 95 No.184,
..... p31 Nov 95 No.185,
..... p38 Jul 04 No.289
Brake Pads Green Stuff (Vitesse) p24 Nov 05 No.305
Brake Pads (Kevlar) p6 Oct 99 No.232,
..... p42 Feb 00 No.236,
..... p47 Nov 00 No.245,
..... p25 Feb 01 No. 248,
..... p25 Aug 05 No.302
Brake Pads p14 Mar 04 No.285
Brake Pad/Shoe Replacement ... p55 Feb 93 No.152
Brake Pipes p41 Jun 88 No.96,
..... p14 Oct 00 No.244
Brakes..... p32 Dec 90 No.126:
..... p47 Jan 91 No.127,
..... p29Feb 91 No.128:
..... p39 Mar 91 No.129,
..... p33 May 91 No.131
Brakes and Suspension (Spitfire Uprated)
..... p10 Dec 99 No.234,
..... p42 Feb 00 No.236



TECHNICAL (all models)

Item	Page & Issue No.	Item	Page & Issue No.
Brakes and Tyres Care	p77 May 97 No.203	Carb Temperature Compensator	p12 Dec 93 No.162
Brake Servicing	p59 Aug 00 No.242, p18,p46 Sep 00 No.243 p77 Dec 00 No.246, p68 Feb 01 No. 248 p20 Nov 85 No.65	Carburettor Pipes	p56 Feb 00 No.236
Brake Servo	p28 Aug 99 No.230	CD Carburettors	p25 Oct. 81 No. 1 (Turning Circle)
Brake Servo Fitting	p33 Jan 88 No.91	Float Chamber Needle Valve Replacement	p15 Mar 04 No.285
Brake Servo Kits	p14 Jan 99 No.223, p40 Mar 99 No.225, p30 May 99 No.227	Fuel Debris/Starvation?	p76 Sep 01 No.255, p74 Oct 01 No.256, p73 Nov 01 No.257, p70 Jan 02 No.259
Brake Servo Positions (Vitesse)	p50 Jan 98 No.211, p11 Apr 98 No.214	Fuel Injection	p74 Nov 01 No.257
Brake Servo Repair Kit	p10 Jun 05 No.300	Fuel Injection Puzzler (TR)	p38 Sep 05 No.303
Brakes: MOT Fail	p24 Feb 86 No.68	Fuel Vaporisation	p64 Aug 00 No.242, p78 Feb 01 No. 248, p76 May 01 No.251
Brake Tips	p35 Jul 87 No.85	Hot Running Spitfire	p77 Jul 01 No.253
Brakes: Stopping Power	p60 July 00 No.241, p77 Nov 00 No.245, p75 Mar 01 No.249, p66 Aug 01 No.254, p75 May 03 No.275	Needles & Carbs (Herald)	p14 Jul 04 No.289
Brake Uprating	p77 Jun 00 No.240	Single or Twin Carbs (Herald)	p18 Jun 04 No.288
Brake Upgrade Tips	p44 Apr 88 No.94, p12,51 Jun 88 No.96	Solex Sorting	p78 Jan 04 No.283
Calipers	p27 Jun 87 No.84	Stromberg Carburettors (Herald)	p38 Nov 96 No.197
Caliper Seal Tip	p21 Jun 02 No.264	Stromberg Problems	p38 Apr 88 No.94
Caliper Tip	p75 Jun 91 No.132, p74 Jun 01 No.252	Stromberg Servicing	p55 Nov 90 No.125, p70 May 91 No.131
Copper brake pipes	p76 Feb 96 No.188	Strombergs Explained	p54 May 90 No.119, p19 Jun 97 No.204, p22 Jul 97 No.205, p62 Sep 97 No.207
Disc Brake Conversion	p70 May 91 No.131	SU Carb Fault	p16 Nov 84 No.53
Drum Brake Adjuster	p24 Feb 84 No.44, p27 Mar 84 No.45	SU Carbs	p20 Aug 01 No.254, p20,p74 Sep 01 No.255
Drum Brakes	p17 Jul 86 No.73	SU Carbs (Vitesse)	p60 Aug 01 No.254
Drum Removal Tip	p46 Dec 85 No.66	SU Snippet	p62 Apr 93 No.154
Disc Concerting" Knock	p32 Oct 99 No.232	SU vs Stromberg	p56 Oct 01 No.256, p48 Mar 04 No.285, p61 Jun 04 No.288, p67 Aug 04 No.290, p71 Sep 04 No.291
Four Pot Brake Conversion	p75 Jun 01 No.252, p61 Aug 01 No.254	Twin Carb Tip	p75 Jun 01 No.252
Four-Pot Calipers	p62 Oct 92 No.148	Triple Stromberg Set-Up	p52 Nov 93 No.161
Girling Powerstop	p33 Oct 98 No.220	Waxstat Conversion	p65 Aug 96 No.194, p53 Sep 96 No.195, p25 Aug 01 No.254, p56 Oct 01 No.256
Handbrake Adjusting	p24 Aug 84 No.50, p42 Feb 85 No.56	Waxstat Tip	p48 Mar 04 No.285
Handbrakes	p77 Nov 00 No.245		
Handbrake Tips	p64 Nov 05 No.305	Car Profiles/Buying:	
Hoses and MOTs	p41 Mar 89 No.105	Automatic Spitfire?	p42 Apr 05 No.298, p60 Aug 05 No.302
Master Cylinder Overhaul	p50 Nov 88 No.101	Brabham Herald Replica	p50 Aug 05 No.302, p56 Sep 05 No.303
Master Cylinders	p42 Jun 88 No.96	Climax Herald and Spitfire	p64 Jun 02 No.264
Master Cylinders (Spitfire)	p12 Jul 80 No.1	Coupe Alternatives	p20 Nov 05 No.305
Power Braking	p42 Mar 99 No.225	Dolomite 1300/1500	p30 Sep 05 No.303
Powerstop	p20 May 02 No.263	Ford Galaxie Skyliner	p54 Aug 05 No.302
Servo Brakes	p11 Dec 93 No.162	Jack Brabham Conversions Ltd.	p64 Jun 02 No.264
Servo Repair Kits	p65 Jun 90 No.120, p50 Jan 98 p211	Maltese Triumphs	p76 Oct 05 No.304
Silicone Fluid		Weekend Racer	p52 May 98 No.215
		Cooling System:	
		Air Scoop	p19 Oct 80 No.4



Item	Page & Issue No.	Item	Page & Issue No.
Anti-Freeze Protection	p27 Nov 92 No.149	Spitfire Distributors	p30 Oct 90 No.124
Cooling System Service	p27 Feb 87 No.80, p37 Mar 87 No.81	Spitfire Jet Igniters	p60 Jan 04 No.283
Cooling System Tips	p75 Nov 00 No.245	'Spitfire' Multi Spark	p54 Aug 97 No.206
Electric Water Pump Fitting	p36 Jul 03 No.277	Electrical:	
Fan Blades (Herald)	p10 Jan 98 No.211	Alarms and Immobilisers	p68 Aug 02 No.266
Hard Water	p5 Sept 80 No.3	Alternator Dismantling	p40 Jun 03 No.276
Heater Hose Tip	p71 Oct 04 No.292	Alternator Fitting/Conversion	p23 Jan 98 No.211, p18 Jan 01 No.247, p52 Feb 01 No.248, p77 Oct 01 No.256, p43 Jun 02 No.264, p26 Feb 04 No.284, p17 Mar 04 No.285
Heating System Tips	p74 Feb 01 No.248	Alternator For Heralds	p26 Aug 85 No.62
Keep Cool	p31 Sep 95 No.183	Alternators	p40 Oct 88 No.100
Kenlowe Fan Fitting	p25 Apr 82 No.2 (Turning Circle), p22 Sept 82 No.27, p22 Dec 82 No.30	Alternators	p55 Apr 90 No.118
Kenlowe Fan Fitting	p27 Sep 88 No.99	Ammeter Fitting	p18 Jun 99 No.228, p78 Oct 02 No.268, p50 Mar 03 No.273
Oil Cooling Air Scoop	p6 Jul 80 No.1	Auto Reset Fog Lights	p10 Feb 03 No.272
Overheating Tip	p71 Jun 00 No.240	Auxiliary Lamps	p24 Feb 01 No.248
Radiator Fans (GT6)	p16 Mar 04 No.285	Ballast System Sorted	p74 Dec 00 No.246
Radiator Overflow Bottle	p32 Jan 88 No.91	Batteries (Advanced)	p58 Apr 00 No.238
Radiator Pressure Cap	p75 Oct 01 No.256	Battery Developments	p59 Dec 93 No.162
Radiator Uprate (Spitfire)	p74 Oct 00 No.244	Battery Drain	p60 Aug 00 No.242 p75,77 Feb 01 No.248 p75 Mar 01 No.249, p70 Apr 01 No.250
Water Cooled Heat Exchanger	p30 Dec 02 No.270	Battery EDTA Update	p6 Jan 90 No.115, p49 Oct 98 No.220
Water Pumps (Vitesse)	p24 Jul 05 No.301	Battery Charging	p61 Dec 97 No.210
Distributors/Ignition System:		Battery Life	p37 Oct 86 No.76
Delco Distributor Advance Curves	p77 Jun 01 No.252	Battery Maintenance & Renovation	p23 Nov 85 No.65
Distributor	p18 Aug 96 No.194	Battery Tips	p76 Jul 01 No.253
Distributor Fitting/Timing (GT6)	p14 May 05 No.299	Battery Warranty	p42 Feb 01 No.248, p78 Jun 02 No.264
Distributor Info	p76 May 01 No.251	Brake Lights Working?	p50 Aug 02 No.266
Distributor Interchangeability	p70 Jun 01 No.252	CB Installation	p15 Feb 82 No.20, p8 Mar 82 No.21
Distributors	p70 Nov 95 No.185	Crankshaft Pulley Nut Removal	p29 Aug 89 No.110
Distributor Swap (Delco Spitfire)	p61 Aug 01 No.254	Dim Lights	p63 Jun 04 No.288
Electronic Ignition	p50 Mar 90 No.117, p48 Apr 96 No.190, p38 May 96 No.191, p14 July 98 No.217, p63 Sep 00 No.243, p74 Oct 00 No.244, p74 Apr 01 No.250, p72 Nov 01 No.257, p43 Jun 02 No.264, p20 Feb 03 No.272, p56 Feb 03 No.272	Door Light Switch (GT6)	p17 Aug 05 No.302
Electronic Ignition (Spitfire 1, 2, 3)	p21 Jun 91 No.132	Dynamo to Alternator	p20 Jan 85 No.55
Electronic Ignition Fitting	p49 Feb 89 No.104	Dynamo to Alternator Conversion	p24 Jul 91 No.133, p65 Nov 94 No.173, p23 Dec 94 No.174, p65 Jan 95 No.175, p10 Feb 95 No.176, p61 May 02 No.263
Distributor/Ignition Tips	p12 Apr 00 No.238	Dynamo to Alternator Converter	p38 Feb 93 No.152
Engine Management	p27 Dec 87 No.90, p18 Jan 88 No.91	Dynamo Polarising/Checking	p22 Dec 99 No.234, p11 Apr 00 No.238
Ignition Cut Out	p46 Oct 87 No.88	Electric Aerial	p53 May 97 No.203
Ignition Fault Found	p44 Aug 04 No.290	Electrical Charging/Discharging Tips	p74 Jun 00 No.240
Ignition System Explained	p25 Nov 81 No.17, p13 Aug 86 No.74	Electrical Burnouts	p14 Oct 98 No.220
Ignition Systems	p62 Jan 96 No.187	Electric Washers	p23 Jul 87 No.85, p8 Nov 99 No.233
Ignition Timing	p22 Oct 96 No.196		
Maestro Ignition	p50 Oct 96 No.196		
Pinking Delay Valves	p71 Jun 01 No.252		
Rotor Arms	p38 May 03 No.275		
Six-Cylinder Distributors	p21 Oct 90 No.124		

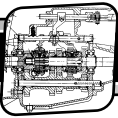

TECHNICAL (all models)

Item	Page & Issue No.	Item	Page & Issue No.
Electric Washers	p29 May 87 No.83, p65 May 98 No.215	90s Lighting for 60s Cars	p45 Mar 90 No.117
Electric Windscreen Washer	p22 Sep 96 No.195	Oil Pressure Gauges	p23 Nov 96 No.197, p26 Dec 96 No.198, p75 May 97 No.203
Electrical System	p30 Oct 85 No.64	Overdrive - Electrical Circuit & Solenoid Removal	p15 Mar 82 No.21
Electrics Tips	p74 Jan 02 No.259, p72 Mar 02 No.261	Overdrive Circuit	p19 Nov 93 No.161
Electrics Tune Up	p22 Jul 96 No.193, p18 Aug 96 No.194	Overdrive Wiring	p4 Feb 81 No.8
Electric TR7	p57 Apr 00 No.238	Period Radios	p42 Mar 90 No.117
Electronic Ignition	p4 Sept. 81 No iS	Petrol Tank Sender	p27 Aug 95 No.182
Electronic Ignition	p56 Jan 86 No.67	Polarity Prognosis	p22 Feb 03 No.272
Electronic Ignition/Kenlowe Fan	p22 Sept 82 No.27, p22 Dec 82 No.30	Positive to Negative Earth Conversion	p27 Apr 86 No.70, p77 Nov 93 No.161, p39 Sep 00 No.243
Flasher Units	p72 Apr 02 No.262, p74 May 02 No.263	Positive to Negative Earth Relay Fitting	p16 Jan 02 No.259
Flick Wipe Switch	p5 Jul 80 No.1	Radio Installation (Her/Vit)	p15 Jan 99 No.223
Flick Wipers	p26 Aug 85 No.62	Radiomobile Radio	p26 Jul 04 No.289
Fog Light Fitting	p39 Apr 91 No.130, p39 July 00 No.241	Rear Fog Lights	p66 Oct 92 No.148, p70 Dec 92 No.150, p53 Feb 93 No.152
Fuse Additions	p14 Nov 94 No.173	Reversing Lamp Fitting (Herald/Vitesse)	p14 Aug 00 No.242
Fuse Box Tips	p51 Feb 05 No.296	Rocker Light Switch	p59 Jan 95 No.175
Fuses	p58 Feb 89 No.104, p9 July 99 No.229, p77 Feb 01 No.248 p41 Nov 02 No.269	Screen Wash Electric	p70 Nov 92 No.149, p48 Feb 93 No.152
Gauges / Voltage Stabiliser	p47 Mar 92 No.141, p77 Jul 01 No.253, p73 Nov 01 No.257	Sidelight Adaptor Plates (Herald)	p28 Apr 04 No.286
Halogen Conversion	p23 Nov 00 No.245	Side Repeater Lamp Fitting	p14 Jun 00 No.240
Hazard Lights	p68 May 93 No.155, p26 Dec 04 No.294	Smiths Radiomobile Radios	p26 Apr 96 No.190, p14 Jun 04 No.288
Hazzard Flashers	p72 Jul 89 No.109, p47 Sep 89 No.111, p84 Mar 02 No.261	Tail Light Repair (Herald)	p48 Jan 04 No.283
Headlamps	p22 Nov 95 No.185, p11 Jan 96 No.187	Trailer Plugs, Sockets and Lamps	p15 Nov 96 No.197
Headlamps: Care and Adjustment	p45 May 90 No.119	Twin Tone Hooter	p64 Jul 95 No.181, p58 Aug 95 No.182
Heater Fans	p65 Feb 94 No.164, p33 Dec 98 No.222	Voltage Regulator / Gauges Tips	p16 Aug 80 No.2, p47 Mar 92 No.141, p77 Jul 01 No.253, p73 Nov 01 No.257, p77 Jul 01 No.253
Horn Circuits	p22 Dec 84 No.54	Wiper Delay Units	p33,47 Aug 92 No.146, p64 Sep 92 No.147, p25 Nov 02 No.269
Horn Operation	p32 Aug 82 No.26	Wiper Flick Switch	p20 Jun 03 No.276
Horn Problems	p13 Apr 82 No.22, p15 Apr 82 No.22, p15 May 82 No.23, p10 Apr 00 No.238	Wiper Motors	p40 Sep 88 No.99, p34 Jan 98 No.211
Horn Sorting/Tip	p27,58 Aug 95 No.182 p51 Oct 95 No.184, p74 Dec 98 No.222	Wiring	p38 Sep 02 No.267
Horn Wiring	p18 Sep 00 No.243, p34 Nov 00 No.245	Wiring Colours	p23 Mar 93 No.153
Interior Light	p15 May 82 No.23	Wiring Looms	p45 Jul 88 No.97
Lights-On Warning Buzzer	p63 Oct 89 No.112	Engine/Ancillaries:	
Lights-On Warning Device	p16 Nov 87 No.89, p50 Jan 87 No.91, p39 Feb 88 No.92, p37 Apr 88 No.94	Anti Drain Oil Filter	p53 Aug 97 No.206, p53 Nov 97 No.209
Lights/Flashers Update	p67 Mar 89 No.105	Anti DrainSystem	p11 Jun 95 No.180
Night Dimming Relay	p75 Nov 01 No.257	Are You Rocking?	p30 Mar 96 No.189, p31 Apr 96 No.190
		Audible Oil Pressure Warning	p37 Feb 88 No.92, p42 Apr 88 No.94, p14 May 88 No.95,

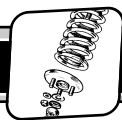

Item	Page & Issue No.	Item	Page & Issue No.
Bearing Clatter	p47 Jun 88 No.96 p49 Jul 88 No.97 p50 Aug 88 No.98, p31 Oct 88 No.100, p49 Nov 88 No.101	Flywheel/Crankshaft Info (6-Cyl)	p46 Jan 05 No.295
BHP for Pennies	p74 Mar 91 No.129	Fuel Consumption Determining	p67 Dec 89 No.114
Big Ends	p29,36 May 88 No.95	Fuel Pump Tip	p26 Nov 04 No.293
Black Cat (Powerplus)	p70 Jan 91 No.127	Fuel Vaporisation	p61 Oct 92 No.148, p70 Dec 92 No.150, p47 Jan 93 No.151, p64 Aug 00 No.242, p78 Feb 01 No.248, p76 May 01 No.251
Broquet Catalyst Comments	p75 May 95 No.179 p79 Jun 95 No.180	Head Gasket Tip	p22 Jan 99 No.223
Cam Uprating	p14 Sept 85 No.63	Head Work	p26 Apr 97 No.202 p19, May 97 No.203
Camfollower Tip	p25 Mar 87 No.81	Heated Manifold	p26 Nov 04 No.293
Camshaft Fitting	p48 Apr 05 No.298	Herald Engine Replacement?	p66 Aug 01 No.254, p76 Nov 01 No.257, p81 Feb 02 No.260
Catalytic Converters	p33 Feb 93 No.152	Herald 1200 'head water delivery tube	p60 Oct 99 No.232
Choke Cable Brea	p72 Jan 02 No.259	High Pressure Rocker/Feeds	p67 Jun 90 No.120
Compression Ratios Tips	p68 Aug 01 No.254, p78 Nov 01 No.257	Hi-Torque starters	p80 Sep 02 No.267
Crankcase Blockages	p72 Sep 01 No.255	Hot/Cold Inlet Manifolds	p34 May 89 No.107
Crankcase Breather Valve	p11 Oct 95 No.184	Inlet Manifolds	p54 Oct 02 No.268
Crankshaft End Float	p58 Feb 91 No.128	Inlet Manifold Fitting	p74 Apr 01 No.250
Cylinder Head Differences	p74 Dec 00 No.246	Lead Free Heads (also see 'Unleaded')	p62 Jan 90 No.115
Cylinder Head Gasket	p61 Aug 00 No.242	Lubrication System	p67 Aug 98 No.218
Cylinder Head Oil Feed?	p61 Sep 00 No.243, p40 Feb 01 No.248 p34 Apr 01 No.250	Lubrication System: Six-Cylinder	p64 Dec 89 No.114
Cylinder Head Oil Weep Tip	p52 Apr 05 No.298	Magnetic Sump Plug	p22 Jun 04 No.288, p10 Jan 05 No.295, p22 Feb 05 No.296
Cylinder Head Removal Tips	p74 Sep 01 No.255, p72 Nov 01 No.257	Misfire Cured	p17 Sep 85 No.63
Cylinder Heads (Spitfire)	p79 Nov 00 No.245	Misfiring Under Load	p76 Oct 00 No.244
Cylinder Head Stud Removal Tip	p25 Aug 88 No.98	Modified 2-litre Engines	p9 Nov 85 No.9 (Turning Circle)
Cylinder Head Torque (GT6)	p53 Aug 03 No.278	Modifying Vitesse/GT6 Flywheels	p12 Jun 86 No.72
Electric Fan Conversion	p40,p74 Aug 01No.254	Octance Boosters	p27 Apr 82 No.2 (Turning Circle)
Electric Fan Fitting (Spitfire)	p15 Jan 01 No.247	Oil	p74 Jul 95 No.181, p78 Aug 95 No.182, p51 Sep 95 No.183, p49 Nov 95 No.185, p39 Feb 00 No.236
Emission Control	p31 Mar 91 No.129	Oil Consumption Check List	p16 Oct 81 No.16
Engine Bore Wear	p23 Nov 83 No.41	Oil Conversion Kits	p5 Jul 84 No.49
Engine Decarbonising	p37 Feb 85 No.56, p44 Mar 85 No.57	Oil Cooler Fitting	p26 Aug 86 No.74, p18 Apr 97 No.202, p39 Aug 02 No.266
Engine Decarbonising	p57 Aug 96 No.194, p55 Sep 96 No.195	Oil Coolers	p67 Apr 89 No.106
Engine Efficiency	p77 Jul 91 No.133	Oil Distribution at High RPM	p64 Oct 05 No.304
Engine Failure/Rich Running Tip	p46 Jun 02 No.264	Oil Filter Anti Drain Device	p67 Jan 93 No.151
Engine Interchangeability?	p70 Nov 00 No.245	Oil Filter (High Capacity)	p16 Nov 05 No.305
Engine Mount Tip	p19 Oct 03 No.280	Oil Filter Tester	p81 Nov 03 No.281
Engine Oil	p70 Nov 96 No.197, p55 Jan 97 No.199	Oil Froth	p45 Aug 84 No.50
Engine Prefixes (Spitfire)	p10 Jul 05 No.301	Oil Leaks	p18 Jan 04 No.283, p16 Apr 04 No.286
Engine Tips	p53 Apr 05 No.298	Oil Pressure	p61 Sep 00 No.243, p74 Nov 00 No.245
Engine Transplant (Spitfire)	p28 Oct 00 No.244	Oil Pump Priming Tip	p67 Jun 90 No.120
Engine Trolley	p76 Aug 92 No.146	Oil Technology	p19, Feb 90 No.116
Engine Tuning	p26 Sep 96 No.195		
Engine Uprating	p75 Oct 01 No.256, p54 Mar 02 No.261, p56 Feb 05 No.296, p54 Apr 05 No.298		
Extractor Manifold on a Spitfire	p81 Feb 02 No.260		
Fiat Twin Cam Engine	p56 Aug 89 No.110		
1500 Spitfire Engine/Box into Herald	p76 Oct 01 No.256		
Flashing Indicator Operation	p44 May 85 No.59		



TECHNICAL (all models)

Item	Page & Issue No.	Item	Page & Issue No.
Oil Temperature	p43 Apr 88 No.94	1300/1500 Engine Tuning	p21 Mar 88 No.93
Oily Bits	p10 Mar 05 No.297, p16 Apr 05 No.298	Throttle Cables (GT6)	p76 Jun 05 No.300
Petrol Additives	p22 Mar 82 No.21	Throttle Linkages	p23 Jul 87 No.85
Pinking	p20 Aug 87 No.86	Throttle Linkages	p22 Mar 92 No.141
Pinking Delay Valves	p71 Jun 01 No.252	Throttle Tips	p74 Sep 01 No.255, p73 Nov 01 No.257
Pinking/Running On Cure	p74 Dec 80 No.126	Thrust Washers	p25 Dec 99 No.234
Piston Reboring Displacements	p62 Nov 89 No.113	Timing	p22 Mar 82 No.21
Piston Ring Fitting	p26 Feb 86 No.68	Timing Chain Replacement	p51 Nov 92 No.149, p42 Feb 98 No.212, p65 Mar 98 No.213
Pistons: Flat/Domed (GT6)	p24 Jun 05 No.300	Timing Chains	p22 Oct 85 No.64, p8 Dec 01 No.258
Power Curves	p31 Feb 88 No.92	Timing Mark	p19 May 99 No.227
Power Increase (Herald)	p22 Jan 03 No.271	Timing Tips	p70 Oct 00 No.244
Pre-engaged Starters	p50 May 88 No.95	Top Dead Centre Gauge	p69 Aug 03 No.278
Pressure Relief Valve Tip	p67 May 00 No.239	TR5 Camshaft in 2 Litre?	p79 Oct 01 No.256
Radiator Fans (GT6)	p16 Mar 04 No.285	TR5 Gas Flowed Head (Spitfire 6)	p16 Jun 03 No.276
Remote Oil Filter	p37 Feb 87 No.80	Triple SU Manifolds	p10 Dec 01 No.258
Remote Oil Filter	p52 Aug 87 No.86, p20 Sep 87 No.87	TR7 Gearbox Swap?	p75 Sep 01 No.255
Rocker Clearance/Shaft Tips	p65 Aug 01 No.254, p74 Sep 01 No.255	Turbocharged	p54 Mar 88 No.93
Rocker Oil Feed	p40 Feb 01 No.248, p34 Apr 01 No.250, p74 Jun 01 No.252	2.5 PI Conversion	p23 Apr 95 No.178
Rocker Shaft Lubrication	p47 Oct 89 No.112, p62 Jul 93 No.157	Unipart Oil Filters	p63 Jan 90 No.115
Rocker Shaft Oil Starvation	p6 Jul 80 No.1 p19 Oct. 80 No.4	Unleaded Cylinder Heads	p42,67 Jun 99 No.228 p8,52 Aug 99 No.230 p52 Sep 99 No.231, p36 Jul 01 No.253
Rocker Shaft Overhaul	p7 Dec 80 No.6	Vacuum Gauge Figures	p77 Nov 01 No.257
Rocker Shaft Upgrade	p64 Nov 99 No.233	Valve Adjustment	p39 Mar 86 No.69
Roller Rockers	p56 Feb 05 No.296, p54 Apr 05 No.298	Valve Guide Tool	p18 Sep 88 No.99
Running On/Pinking	p20 Jan 82 No.19, p32 Aug 82 No.26, p76,May 89 No.107 p28 Jun 89 No.108, p9 Aug 97 No.206, p79 Apr 01 No.250	Valve Guide Wear	p18 Jan 82 No.19
SC Engine Development	p68 Oct 05 No.304, p68 Nov 05 No.305	Valve Hardness Test	p70 Feb 00 No.236
Seized Engine Starting	p74 Apr 01 No.250	Valve Lap Tip	p28 Jun 89 No.108
Silent Starter Motor	p72 Apr 02 No.262	Valve Seals	p35 Mar 99 No.225
Six Cylinder Engine Code Letters	p54 Jan 04 No.283	Valve Spring Replacement	p48 Apr 02 No.262, p75 May 02 No.263
Six-Cylinder Tuning	p14 Jul 88 No.97	Valve Timing	p62 Oct 96 No.196, p57 Nov 96 No.197
Smooth Six Evolution	p21 Jun 89 No.108	Valve Timing 6-Cyl	p76 Nov 99 No.233
Spark Plug Fault - Hairline Crack	p40 Jul 83 No.37	Vandervell Bearings	p6 May 96 No.191
Spark Plugs	p44 Apr 90 No.118	Vitesse Engine Replacement?	p80 Feb 02 No.260
Spark Plug Info N9Y	p79 Mar 99 No.225	Water Injection	p37 Nov 85 No.65
Spin On Oil Filter	p18 Feb 05 No.296	Exhaust Systems:	
Starter Motor Gear Lubrication	p12 May 98 No.215	Bell's Silencer Manufacture	p35 Mar 90 No.117, p50 Apr 90 No.118
Starter Motor Sticking/Problems?	p68 Sep 00 No.243, p77 Apr 01 No.250, p71 Jun 01 No.252	Exhaust Manifold	p61 Oct 84 No.52
Supercharging	p10 Oct 86 No.76, p66 Dec 02 No.270	Exhaust Manifold Design	p76 Jul 05 No.301, p10 Aug 05 No.302
The Purrfect Six - Engine Rebuild	p24 Nov 87 No.89, p21 Dec 87 No.90, p20 Jan 88 No.91, p18 Feb 88 No.92,	Exhausts (Herald)	p36 Apr 03 No.274
		Exhausts (Specials)	p28 Dec 98 No.222, p46 Mar 99 No.225
		Exhausts Twin System Comments/Alternatives	p37 Oct 83 No.40
		Stainless Steel Exhausts	p44 Nov 85 No.65
		Triumphtune Exhausts	p53 May 90 No.119
		General/Miscellaneous:	
		Acceleration and Top Speed	p65 Jul 89 No.109

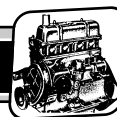

Item	Page & Issue No.	Item	Page & Issue No.
Accessories/Instruments Fitting	p28 Jan 97 No.199, p79 Mar 97 No.201, p70 May 97 No.203	Garages and Carports	p78 Oct 04 No.292, p54 Nov 04 No.293
Air Filters	p14 Feb 03 No.272	Gas Struts	p72 Dec 03 No.282
Alford and Alder	p45 Jun 01 No.252	General Sorting Tips (Spitfire)	p58 Apr 04 No.286
Alloy Products	p66 Oct 02 No.268	Girl's A-Z Restoration Guide	p50p Jan 05 No.295
Anti Theft Device	p47 Mar 95 No.177	Go Racing!	p78 Apr 99 No.226
Auxillary Gauges Part 2	p41 Jul 89 No.109	Grinding Hazard	p61 Jun 05 No.300
Back on the Road Tips	p77 Apr 91 No.130	Gunson's Gastester on Test	p67 Jun 95 No.180.
Books / Manuals	p28 Aug 05 No.302, p74 Oct 05 No.304	Handy Hints	p38 Mar 99 No.225
Braided Pipe Warning	p75 May 02 No.263	Head Up Display (GT6)	p46 Aug 86 No.74
Buying Online	p22 Nov 04 No.293	Heater Tip	p24 Feb 86 No.68
Buying Secondhand	p34 Feb 85 No.56	Heater Control Valves	p39 Apr 99 No.226
Buying Secondhand Cars	p14 Feb 90 No.116	Herald/Vitesse Seatbelts	p68 Mar 96 No.189
Car Alarms	p19 May 86 No.71	Hot Starting problems	p71 Jun 01 No.252
Child Seat Belts	p10 Oct 90 No.124	Inertia Seat Belt Fitting (Herald/Vitesse Conv.)	p60 Apr 01 No.250
Child Seats	p9 Jul 89 No.109, p53 Sep 89 No.111	Insurance Values	p26 Sep 99 No.231
Clarence Engineering Co.	p70 May 05 No.299	IVR Update	p19 July 98 No.217, p35 Sep 99 No.231, p10 Oct 99 No.232,
Classic British Quality Charter	p72 Oct 04 No.292		p46 Jan 00 No.235, p66 Mar 00 No.237
Code Numbers (Spitfire)	p24 Aug 03 No.278	Jump Start Tip	p61 Oct 92 No.148
Component Codes	p31 Sep 91 No.135	Kenlowe Hotstart	p38 Jan 93 No.151, p46 Mar 93 No.153
Concours Marking/Preparation	p70 Nov 97 No.209, p49 Dec 97 No.210	Laying-up Cars	p31 Feb 84 No.44
Concours	p42,54 Sept 98No.219, p10 Nov 98 No.221, p55 Dec 98 No.222, p59 Jan 99 No.223, p29 Feb 99 No.224, p59 Mar 99 No.225, p26 Apr 99 No.226, p22 May 99 No.227 p10 Jun 99 No. 228 p8 July 99 No.229, p27 Sep 99 No.231, p31 Mar 00 No.237, p18 Apr 00 No.238, p59 May 00 No.239 p63 Jun 00 No.240	Lead Free (also see 'Unleaded')	p6 Sep 90 No.123, p57 Oct 90 No.124, p6 Dec 90 No.126
Convertible Car Crime	p9 Oct 98 No.220	Lead Free Petrol	p57 Feb 89 No.104, p55 May 89 No.107, p4 Jun 89 No.108, p17 Jul 89 No.109, p5,18 Aug 89 No.110, p19, 47 Sep 89 No.111 p15 Nov 89 No.113, p28 Feb 90 No.116
Cork Fuel Sender!	p56 Jul 03 No.277	Lead-Free Petrol Special	p26 Oct 85 No.64
Crash Helmet Labels	p5 Jul 83 No.37, p5 Nov 83 No.41	Maestro Parts for Triumphs	p46 Aug 98 No.218
Drivetrain Comments	p33 Mar 84 No.45	Secure Stowage Space: Spitfire/GT6	p46 Nov 98 No.221
Emissions Testing?	p74 Dec 03 No.282, p70 Jan 04 No.283	Misfiring Tips (GT6)	p75 Jun 01 No.252
Eversure Fillacan	p80 Jul 05 No.301	MOT	p10 Aug 89 No.110, p29 Mar 90 No.117 p8 Sep 93 No.159
Four Star Leaded Petrol Sites	p66 Jun 00 No.240	MOT Bits	p18 Jan 91 No.127
Fuel Additives' News	p26 Nov 99 No.233, p8,67 Dec 99 No.234 p65 Mar 00 No.237, p63 Apr 00 No.238	MOT Emissions	p35 Sep 01 No.255
Fuel Economy	p76 Nov 90 No.125	MOT Tester Tips	p45 Feb 89 No.104
Fuel Quality	p14 Mar 04 No.285	Nuts and Bolts	p25 Sep 84 No.51
Fuel Tanks (Spitfire)	p56 Mar 05 No.297, p32 Apr 05 No.298, p78 Aug 05 No.302	Nuts and Torques	p79 Jul 01 No.253, p77 Nov 01 No.257, p76 Jan 02 No.259, p32 Feb 02 No.260
		Oil / Oil Filter Tips	p29 May 03 No.275
		Oil Gun	p35 Feb 97 No.200
		Outside Temperature Gauge	p26 Sep 91 No.136, p35 Oct 91 No.135, p30 Nov 91 No.137
		Parts Commonality	p35 Apr 83 No.34
		Parts interchangeability	



TECHNICAL (all models)

Item	Page & Issue No.	Item	Page & Issue No.
Passing The MOT	p7 Jun 81 No. 12		p38 Feb 00 No.236,
Petrol Additives' Results/ News	p62 May 99 No.227		p10 Apr 00 No.238,
	p26 Nov 99 No.233,		p62 May 00 No.239,
	p8,67 Dec 99 No.234		p70 Jun 00 No.240
	p65 Mar 00 No.237	Tax Disc Security	p27 Apr 86 No.70
Petrol Grades and Use	p15 Feb 96 No.188,	Technical Secretary/Talking Technical	p42 Mar 99 No.225,
	p5 May 96 No.191		p22 Apr 99 No.226,
Preparing for the Season	p57 May 96 No.191		p18 Jun 99 No.228
Rain-X	p75 Feb 95 No.176,	Theft Deterrent	p67 Feb 93 No.152
	p11 Mar 95 No.177,	Theft Proofing	p49 Feb 86 No.68
	p7 Apr 95 No.178,	Threads (nuts & bolts)	p48 Oct 86 No.76
	p81 Jun 95 No.180	Threads, Nuts and Bolts	p18 Aug 92 No.146
Recon or Con?	p43 Dec 89 No.114	Towbars	p26 Nov 91 No.137,
Repro Components	p30 July 98 No.217,		p48 Aug 95 No.182
	p8 Aug 98 No.218	Tragonic Prevent a Crash	p19 Jul 01 No.253,
Rolling Road Tip	p47 Jun 02 No.264		p33 Oct 01 No.256
Rust Killing	p54 Apr 03 No.274,	Trailer Tent Buyer's Guide	p18 Jun 96 No.192
	p74 May 03 No.275	Triplex Glass Dating	p49 Jun 02 No.264
Rustproofing	p5 Jan. 81 No.7,	Tuning	p12 May 84 No.47,
	p14 Feb 81 No.8		p26 Jun84 No.48,
SAH: Tuning Houses	p54 May 02 No.263		p77 July 98 No.217,
Sealing Leaks	p4 Nov.80 No.5,		p74 Aug 98 No.218,
	p7 Jan 81 No.7		p70 Sept 98 No.219
Seat Belts	p40 Sep 03 No.279,	Tuning a Standard Triumph	p77 July 98 No.217,
	p53 Nov 03 No.281		p74 Aug 98 No.218,
Seat Belt Safety	p47 Mar 93 No.153		p70 Sept 98 No.219
Security	p22 Jan 91 No.127	Tuning Houses	p64 Jun 02 No.264,
Security Devices	p11 Jun 89 No.108		p70 Jul 02 No.265,
Security Tip	p49 Feb 86 No.68,		p80 Aug 02 No.266,
	p45 Mar 86 No.69		p74 Sep 02 No.267,
Security Tips	p50 Feb 92 No.140,		p76 Oct 02 No.268,
	p39 Aug 94 No.170		p74 Nov 02 No.269,
Service Items	p15 Sep 89 No.111		p66 Dec 02 No.270,
Service Sheet Herald 13/60	p42 Jan 97 No.199		p76 Jan 03 No.271,
Servicing Herald 13/60	p46 Jul 90 No.121		p64 Feb 03 No.272
Servicing Tips	p69 Dec 00 No.246	200 Motoring Gadgets	p46 Oct 03 No.280,
Servicing Your Herald	p23 Oct 95 No.184,		p52 Nov 03 No.281,
	p27 Nov 95 No.185,		p47 Dec 03 No.282,
	p33 Dec 95 No.186,		p61 Jan 04 No.283,
	p28 Jan 96 No.187,		p49 Feb 04 No.284,
	p10 Mar 96 No.189,		p32 Mar 04 No.285,
	p26 May 96 No.191		p35 Apr 04 No.286,
	p32 Jun 96 No.192		p59 May 04 No.287,
Servicing Your Tent / Caravan	p18 Mar 96 No.189		p51 Jun 04 No.288
Sheared Stud Tips	p30 Jan 87 No.79		p67 Jul 04 No.289,
Spares Sugestions	p38 Mar 04 No.285		p33 Aug 04 No.290,
Speedo Calibration	p79 Jun 01 No.252		p45 Sep 04 No.291,
Speedometers	p30 Aug 87 No.86,		p37 Oct 04 No.292,
	p40 Dec 87 No.90		p43 Nov 04 No.293,
Speedos	p33 Apr 94 No.166		p35 Feb 05 No.296,
Spitfire Fettleing Tips	p42 Oct 02 No.268		p31 Mar 05 No.297,
Stanpart Accessories	p11 Jul 93 No.157		p46 Apr 05 No.298,
Stored Cars' Checkover	p14 Aug 97 No.206		p24 May 05 No.299,
Tachometers etc.	p70 Mar 00 No.237		p51 Jun 05 No.300,
Talking Technical	p18 Sep 99 No.231,		p54 Jul 05 No.301,
	p18 Oct 99 No.232,		p47 Aug 05 No.302,
	p22 Dec 99 No.234,		p43 Sep 05 No.303,
	p8 Jan 00 No.235,		p29 Oct 05 No.304

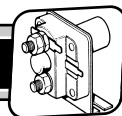

Item	Page & Issue No.	Item	Page & Issue No.
2-Litre Tuning Comments	p43 Apr 85 No.58	Heater Operating Valve	p12 Sep 95 No.183
2.5L in GT6?	p76 Apr 01 No.250	Herald/Vitesse Heater Overhaul	p66 Mar 96 No.189
Unleaded Conversion	p37 Feb 03 No.272	Petrol Tank Removal (Herald)	p28 Nov 00 No.245
Unleaded Fuel (Vitesse)	p14 Jun 05 No.300,	Quarterlight Conversion on Spitfire	p77 Oct 01 No.256,
	p80 Jul 05 No.301,		p71 Jan 02 No.259
	p15 Sep 05 No.303	Seat Belt Fitting	p29 Apr 87 No.82,
Unleaded Petrol	p20,61 Mar 98 No.213		p9 Mar 93 No.153
	p23 Apr 98 No.214,	Seat Belts	p40 Sep 03 No.279,
	p63 May 98 No.215		p53 Nov 03 No.281
	p70 Aug 98 No.218,	Seat Mounting Repair	p51 Sep 88 No.99
	p50,60Sept 98 No.219	Steering Wheel Renovation Tip	p53 Jan 96 No.187,
	p60 Nov 98 No.221,		p51 Feb 96 No.188
	p49 Jan 99 No.223,	Tow Bar Fitting	p32 Aug 96 No.194,
	p5,10,38 Feb 99 No.224		p31 July 98 No.217,
Weatherproofing	p10,79 Mar 99 No.225		p26 Dec 98 No.222,
	p10 Apr 99 No.226,		p38 Apr 99 No.226
	p10,62, 75 May 99	Vitesse Preparation - Spirit of Adventure	
	No.227		p22 Oct 98 No.220,
	p14, p62, p65,		p31 Nov 98 No.221
	p80 Aug 00 No.242,	Window Seal Fitting Tool	p22 Jun 04 No.288
	p60 Sep 00 No.243,	Window Winder Customised	p59 Apr 02 No.262
	p70 Oct 00 No.244	Windscreen Fitting	p74 Apr 02 No.262
Unleaded Tips	p8 Jan 00 No.235,	Wiper Box Wear	p38 Nov 86 No.77
	p79 Jun 00 No.240	Wiper Tips	p80 Jul 01 No.253,
Unleaded Petrol/Catalytic Converters	p33 Feb 93 No.152		p72 Jan 02 No.259
Upgrading Tips (general)	p78 Mar 01 No.249		
Water Leaks (Spitfire)	p15 Sept 98 No.219	Paint:	
Waxoyl Tip	p10 July 99 No.229	Bond Body Colours	p56 Mar 01 No.249
Weatherproofing (Spitfire)	p8 Dec 98 No.222	Brush Repaint	p70 Aug 94 No.170,
	p30 Jan 04 No.283		p63 Oct 94 No.172,
Website Design	p61 Nov 05 No.305	Paint & Trim Combinations (Vitesse)	p67 Jan 95 No.175
Windscreen Washer Bottle Replacement		Paint Chart	p35 Jun 01 No.252
	p46 July 99 No.229	Paint Formulation	p33 Jun 01 No.252
Winter Driving	p4 Jan 84 No.43,	Paint Schemes	p18 July 99 No.229
	p14 Jan 05 No.295	Semi Gloss Paint for Suspension	p58 Oct 02 No.268
Winter Laying Up/Preparation	p15 Sep 86 No.75,	Spraying	p66 Jun 90 No.120
	p31 Dec 91 No.138,		p11 Jul 82 No.25,
	p10 Feb 92 No.140,		p9 Aug 87 No.86,
	p14 Dec 03 No.282		p26 Sep 87 No.87,
Winter Tips	p32 Nov 85 No.65,		p51 Jan 93 No.151,
	p20 Dec 85 No.66,		p57,77 Apr 94 No.166
	p4 Oct 88 No.100,	Touch Up Paints	p24 Nov 05 No.305
	p11 Nov 88 No.101,	Wheel Colour	p14 Jun 02 No.264
	p30 Dec 88 No.102,		
	p24 Jan 89 No.103	Restoration	
Wire Wheel Care	p59 Feb 91 No.128	Bullet Rebuild	p60 Aug 04 No.290
Unleaded Fuel Use	p8 Oct 97 No.208,	Restoration Guide	p50 Jan 05 No.295
	p69 Dec 97 No.210	Restorations (Herald)	p62 Jan 05 No.295,
			p27 Feb 05 No.296
		Restoration (TR5)	p74 Feb 04 No.284,
			p72 Mar 04 No.285,
			p64 Apr 04 No.286,
			p76 May 04 No.287,
			p77 Jun 04 No.288,
			p76 Jul 04 No.289
		Restoration Observations	p67 Aug 05 No.302
		Restorations (Vitesse)	p12 Nov 04 No.293,
			p18 Feb 05 No.296

Mechanicals (Other):

Bonnet Catches	p57 Jun 03 No.276
Bonnet Locks	p39 Dec 94 No.174,
	p24 Feb 95 No.176
Bonnet Lock Fitting	p50 Mar 02 No.261
Door Glass Remedy (Spitfire)	p10 Mar 99 No.225
Door Hinge Refettling	p26 Nov 97 No.209
Gas Struts for Bonnets	p53 Jul 97 No.205
Handbrake Adjustment	p29 Aug 96 No.194

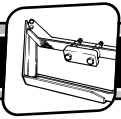

TECHNICAL (all models)

Item

Page & Issue No.

Suspension and Steering:

Adjustable Shock Absorbers	p39 Jun 83 No.36
Air Shocks	p34 Mar 99 No.225
Ball Joints	p16 Nov 84 No.53, p30 Dec 84 No.54, p8 Jan 85 No.55
Bushes - Uprated	p7 Aug 93 No.158
Bump Stops	p60 Mar 00 No.237, p46 Jun 00 No.240
Camber Compensator	p62 Aug 95 No.182, p67 Oct 95 No.184, p53 Nov 95 No.185, p60 Mar 96 No.189, p54,62 Nov 99 No.233 p63 Dec 99 No.234
Dampers Explained	p38 Oct 97 No.208
Early Wishbones (Herald)	p26 Feb 05 No.296
Front Spring & Shock Absorber Assembly	p20 Jun. 82 No.24
Front Springs (Uprated Mounting Rubbers)	p4 Aug 83 No.38
Front Suspension Shims	p75 Feb 94 No.164
Front Suspension Thoughts	p38 Nov 00 No.245, p47 Dec 00 No.246, p64 Oct 01 No.256
Front Trunnion Replacement	p29 Aug 86 No.74
Front Trunnions, Suspension and Discs	p51 Mar 92 No.141, p51 Apr 92 No.142
Front Trunnion Tip	p70 Jun 00 No.240
Handling Mod Tips	p79 Nov 00 No.245
Rear Anti-Roll Bar	p28 Feb 82 No.20
Rear Hub Jacking Device	p14 Jun 03 No.276
Rear Spring Compensator	p64 Feb 03 No.272
Rear Spring and Suspension Wear	p45 Jan 90 No.115, p56 Feb 90 No.116, p81 Apr 90 No.118
Rear Spring Info	p38 Feb 00 No.236
Rear Spring Replacement	p39 Dec 86 No.78
Rear Spring Replacement	p62 Oct 89 No.112
Rear Springs:	p19 Dec 80 No.6, p10 Apr 81 No.10, p40 Dec 83 No.42, p45 Dec 04 No.294
Rear Spring Tips	p64 Aug 01 No.254, p76 Jan 02 No.259, p82 Feb 02 No.260
Rear Suspension Bolt Shear	p15 Apr 82 No.22
Rear Suspension Lean	p60 July 99 No.229, p18 Oct 99 No.232, p59 Nov 99 No.233
Rear Suspension Problems	p59 Aug 93 No.158
Rear Suspension Tuning	p54 May 97 No.203
Rear Trunnion Bolt Change	p8 Apr 81 No.10
Rear Trunnion Bolt - Grease Nipple Conversion	p5 Feb 81 No.8, p16 Apr 81 No.10
Rear Trunnion Bolt Shear	p20 Dec 80 No.6

Item

Page & Issue No.

Rear Trunnion Bush Replacement	p39 Sep 86 No.75, p34 Nov 86 No.77, p37 Mar 87 No.81
Roll Centres, Camber, Chassis and Things	p38 Jul 84 No.49
Rotoflex Couplings	p15 Oct 82 No.28
Rotoflex Shocks Conversion	p78 Jun 01 No.252
Rotoflex Suspension Explained	p50 Dec 94 No.174
Rotoflex Suspension Mod.	p38 May 96 No.191
Rotoflex Suspension Rebuild	p51 Jul 92 No.145, p51 Aug 92 No.146
Shock Absorbers - Air Assisted	p30 Apr 86 No.70
Shock Absorbers (Rear GT6)	p60 Aug 01 No.254
Spax Adjustables Settings	p40 Aug 99 No.230, p38 Sep 99 No.231, p10 Jan 00 No.235
Spring Clamp Plate	p20 Jul 82 No.25
Spring Compressors	p74 Jul 92 No.145
Spring Rates	p40 Oct 83 No.40
Springs (Specials)	p16 Aug 04 No.290, p72 Sep 04 No.291
Springs and Dampers	p15 Feb 98 No.212
Steering / Front Suspension	p10 Mar 96 No.189
Steering Column Bush	p38 Aug 85 No.63, p44 Nov 85 No.65, p30 Jun 86 No.72, p11 Feb 98 No.212
Steering Column UJ	p29 May 03 No.275
Steering Column Locks	p40 Oct 03 No.280
Steering Couplings	p47 Dec 00 No.246, p37 Oct 03 No.280
Steering Rack Gaiter Replacement	p54 Sep 95 No.183
Steering Rack Mounts	p18 July 94 No.169, p18 Oct 98 No.220
Steering Rack Regearing/Upgrade	p47 Jun 00 No.240
Steering Rack Replacement	p45 Feb 90 No.116
Steering Racks	p24 Feb 91 No.128, p55 Mar 91 No.129, p58 Jul 04 No.289
Steering Universal Joint Fitting	p23 Sept 98 No.219
Steering Wheel Reconditioning	p40 Jul 02 No.265
Stiff Steering	p79 Mar 01 No.249
Suspension Advice	p42 Feb 85 No.56
Suspension Alignment	p78 Nov 91 No.137
Suspension Bushes	p18 Jun 88 No.96
Suspension Design	p62 Dec 00 No.246, p22 Mar 01 No.249
Suspension Geometry (Spitfire)	p41 Apr 99 No.226
Suspension Knock Tips	p76 Oct 01 No.256
Suspension Sag	p18 Jun 99 No.228
Suspension Set Up	p63 Aug 01 No.254, p69 Mar 02 No.261
Suspensions Sussed	p27 Aug 93 No.158, p78 Sep 93 No.159, p62 Oct 93 No.160, p14 Dec 93 No.162
Suspension / Transmission Tips	p31 Oct 94 No.172
Suspension Tuning	p4 Oct 87 No.88

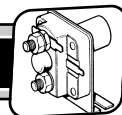

Item

Page & Issue No.

Suspension Turrets GT6 vs Spitfire	p42 Nov 99 No.233
Suspension Tuning	p4 Oct 87 No.88
Suspension Upgrade?	p12 Nov 00 No.238
Suspension Upgrading (Hurricane)	p8 Nov 04 No.293
Swing, Flex or Compensate	p18 Nov 03 No.281
Swing or not to Swing	p25 Aug 82 No.26
Swing Spring	p41 Dec 87 No.90
Swing Spring Conversion	p18 Oct 94 No.172,
	p11 Nov 94 No.173,
	p67 Dec 94 No.174,
	p15 Feb 95 No.176,
	p76 Nov 01 No.257
Swing Spring Herald	p46 Aug 99 No.230
Swing Spring Mounting Box	p76 Jun 01 No.252
Tite-a-Turn	p40 Dec 87 No.90
Track Check	p41 Oct 84 No.52
Trunnion Bush Replacement	p53 Sep 87 No.87
Trunnion Teaser	p35 Apr 92 No.142
Trunnions	p6 May 86 No.71
Trunnions	p75 Sep 95 No.183
Trunnions - Oil or Grease?	p4 Feb 85 No.56,
	p22 May 85 No.59
Trunnion Oiling	p5 Sep 97 No.207,
	p53 Oct 97 No.208,
	p53 Nov 97 No.209,
	p63 Feb 98 No.212
Trunnion Oil Gun	p40 Sep 03 No.279
Trunnion/Vertical Link Temporary Repair	
	p36 Oct 83 No.40
Trunnion Tips	p71 Sep 01 No.255,
	p76 Jan 02 No.259
Unsprung Weight	p16 Oct 84 No.52
Vertical Link Inspection	p70 Feb 97 No.200
Vertical Links	p14 Oct 02 No.268

Towing:

Tow Bar DIY (Herald)	p28 Jun 02 No.264
Towbar Fitting	p26 Aug 02 No.266
Towing Eyes	p79 Apr 01 No.250
Towing (Trailer)	p11 Jun 88 No.96
Towing / Turning Tips	p18 Mar 97 No.201,
	p10 Apr 97 No.202
Towing Caravans	p18 Jan 96 No.187,
	p10 Feb 96 No.188,
	p18 May 96 No.191
	p22 May 97 No.203
Towing Limits	p16 Jul 97 No.205
Trailer Tips	p72 Sep 02 No.267
Vitesse as a Tow Car	p14 Oct 96 No.196

Transmission:

A "Diff"icult Problem	p15 Jun 86 No.72
Bad Vibrations	p50 May 97 No.203
Clutch Bearing Carrier Dent	p22 Feb 05 No.296
Clutch Centring Tool	p46 Jul 92 No.145
Clutch Failure Tip	p37 Apr 88 No.94
Clutch Faults	p68 July 94 No.169
Clutch Fundamental Principles/Problems	

Item

Page & Issue No.

	p47 Aug 8 No.98,
	p50 Sep 05 No.303
Clutch Overhaul	p23 Aug. 80 No.2,
	p19 May 81
	(Turning Circle)
Clutch Plate Alignment	p6 May 86 No.71
Clutch Plate Alignment Tool	p59 Aug 93 No.158
Clutch Release Arm Breakage	p10 May 98 No.215
Clutch Release Arm Pivot Pin Tip	p71 Aug 99 No.230
Clutch Replacement (Spitfire)	p24 Dec 84 No.54,
	p53 Apr 95 No.178,
	p53 May 95 No.179,
	p74 Oct 96 No.196
Clutch Slip (Competition)	p9 Sep 86 No.75
Clutch Sorting	p59 Feb 93 No.152
Clutch Sticking	p29 Aug 87 No.0.86,
	p26 Oct 87 No.88
Clutch Tips	p22 Apr 99 No.226,
	p11 May 99 No.227,
	p19 Jun 99 No.228,
	p74 Feb 01 No. 248,
	p75,78 May 01 No.251
	p76 Sep 01 No.255
Clutch Unsticking Tips	p37 May 87 No.83,
	p23 Jun 87 No.84
Differential Choice	p74 Dec 92 No.150,
	p47 Jan 93 No.151
Differential Differences	p18 Mar 89 No.105
Differential Leaks	p68 Jan 94 No.163
Differential Operation	p46 Nov 90 No.125
Differential Treatment	p 43.Nov 89 No.113
Differentials including Limited Slip	p40 Jun 85 No.60
Differentials and Flanges - Interchangeability	
	p16 Jan 85 No.55
Differentials 4- or 6-stud?	p79 Feb 01 No. 248
Differential Ratios	p78 Oct 01 No.256
Differentials Tips	p18 Jul 86 No.73,
	p20 Aug 03 No.278
Diff/Gearbox Woes	p66 Jun 01 No.252
Diff Replacement (Stag)	p34 Jul 05 No.301
Doughnuts	p68 July 00 No.241
Drive Issues	p62 Aug 00 No.242
Drive Line Vibration Cure	p53 Jan 91 No.127
Drive Shafts	p75 Nov 94 No.173,
	p48 Oct 04 No.292
Driveshaft Safety Tip	p36 Apr 02 No.262
Flexible Drive Servicing	p32 Mar 94 No.165
Front Spring Replacement	p41 Aug 88 No.98
Front Wheel Bearing Replacement	p39 Mar 98 No.213
Gearboxes and Clutches (Spitfire)	p34 Dec 02 No.270,
	p78 Mar 03 No.273
Gearboxes/Overdrives	p78 Oct 00 No.244,
	p71 Nov 00 No.245,
	p62 Jan 01 No.247,
	p76 Apr 01 No.250,
	p74 May 01 No.251
Gearbox Noises	p64 July 00 No.241
Gearbox Oil Seal Tip	p19 Oct 03 No.280

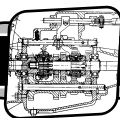

TECHNICAL (all models)

Item	Page & Issue No.	Item	Page & Issue No.
Gear Lever Bushes	p25 Feb 87 No.80, p37 Mar 87 No.81	Overdrive Woes	p66 Dec 04 No.294
Gear Lever Extension (Spitfire)	p41 Aug 01 No.254	Propshaft Orientation	p6 Dec 89 No.114
Gear Lever Rebush	p10 Jul 95 No.181, p62 Dec 95 No.186	Propshaft Rebuild	p51 Apr 98 No.214
Gearbox Cover	p62 Jan 01 No.247	Propshaft Tips	p23 Apr 99 No.226, p74 May 99 No.227
Gearbox Extension Rebuild	p55 Mar 86 No.69	Propshaft Vibration	p20 Oct 80 No.4, p41 Aug 85 No.62, p63 Aug 00 No.242
Gearbox Fumblings (Spitfire)	p18 Aug 98 No.218		p62 Sep 00 No.243, p75 Dec 00 No.246, p60 Jan 01 No.247, p75 Mar 01 No.249, p71,77 Apr 01 No.250
Gearbox Rebuild (2-Litre)	p14 Mar 87 No.81, p24 Apr 87 No.82		p40 Jun 02 No.264
Gearbox Reconditioning	p20 Aug 86 No.74	Rear Hub Jacking Device	p45 Oct 90 No.124
Gearbox Troubles	p70 Sep 94 No.171	Rear Hub Removal/Dismantling	p21 Jan 87 No.79, p78 Dec 00 No.246
Gearbox Uprating	p17 Dec 84 No.54, p20 Feb 85 No.56, p77 May 05 No.299	Rear Hub Bearing Replacement	p22 Aug 99 No.230
	p75 Jun 05 No.300	Rear Wheel Bearing	p75 Jan 02 No.259
Gear Selection	p19 Oct 99 No.232	Rotoflex Conversion	p66 Oct 91 No.136
Gear Selection Sorted (TR)	p46 Jun 05 No.300	Rotoflex Couplings	p15 Oct 82 No.28
Greasing Universal Joints	p44 Jun 85 No.60	Rotoflex Driveshaft Rebuild	p51 Jul 92 No.145, p51 Aug 92 No.146
GT6 and 2000 Gearboxes	p79 Aug 00 No.242	Rotoflex Hub End Float Setting	p51 Nov 94 No.173
GT6 Mk.3 Rear Track	p76 Nov 00 No.245	Rotoflex Rear Suspension Bracket Fitting	p30 Nov 88 No.101
Halfshaft UJ Replacement (Rubber Doughnuts)	p7 May 86 No.71	Rotoflex Tips	p26 Dec 88 No.102, p62 Jan 01 No.247, p78 Jul 01 No.253
Hub Extractor Tool	p17 Jan 85 No.55, p27 Mar 85 No.57		p24 May 02 No.263
Hubs and Axles	p22 Dec 84 No.54	Rotoflex Upgrade	p74 Mar 00 No.237, p58 Jun 00 No.240
Hydrostatic Drive	p30 May 85 No.59	Shock Absorbers/Rear Suspension	p59 Apr 89 No.106
Overdrive	p26 Nov 84 No.53, p19,40 Dec 84 No.54, p14 Jan 85 No.55	Stiff Joints	p50 Mar 01 No.249
Overdrive & Solenoid Protection	p24 Sep 87 No.87	Strengthening Gearboxes	p58 Mar 86 No.69
Overdrive - Electrical Circuit & Solenoid Removal	p15 Mar 82 No.21	Suspension Design	p62 Dec 00 No.246
Overdrive Clutches	p49 Feb 92 No.140	Torque Reaction	p51 Sep 95 No.183
Overdrive Conversions /Tips	p14 Mar 87 No.81, p24 Apr 87 No.82, p15 May 87 No.83, p62 Apr 95 No.178, p65 May 98 No.215	Track Rod End Replacement	p48 Jan 89 No.103
	p36 Oct 01 No.256, p32 Nov 01 No.257, p28 Dec 01 No.258, p71 Jan 02 No.259, p84 Feb 02 No.260	Trunnion Bolt Seized?	p62 Mar 00 No.237
Overdrive Conversion (2-Litre)	p12 Jul 87 No.85, p29 Aug 87 No.86, p24 Sep 87 No.87	2.5 Clutches	p71 Mar 00 No.237
Overdrive Gearknob Mod.	p78 July 99 No.229	Universal Joints	p18 Apr 98 No.214
Overdrive Service	p23 Mar 91 No.129, p63 May 91 No.131	UJ Circlips	p74 Mar 94 No.165, p50 Oct 97 No.208, p61 Nov 99 No.233, p76 Jun 00 No.240
Overdrive Servicing (D-Type)	p15 May 87 No.83	UJ Knocks	p75 Nov 01 No.257
Overdrive Slip	p25 Dec 99 No.234, p11 Jan 00 No.235, p63 May 00 No.239	UJ Replacement	p43 Jan 87 No.79, p24 Mar 87 No.81, p63 Sep 03 No.279
	p60 Jan 01 No.247	UJ Update	p8 Mar 89 No.105
Overdrive (Spitfire)	p27 Mar 99 No.225	Universal Joints	p51 Sep 92 No.147
Overdrive Wiring	p4 Feb 81 No.8, p70 Jun 00 No.240	Vibration Tips	p62 Aug 01 No.254, p77 Sep 01 No.255, p86 Feb 02 No.260

Trim:

Bonnet Catches	p57 Jun 03 No.276
Bonnet Seals	p77 May 01 No.251
Boot Tidy (Herald/Vitesse)	p10 Mar 01 No.249
Carpet Colour Renovation	p15 Jul 86 No.73
Carpet Fitting (Spitfire)	p10 Apr 99 No.226, p11 May 99 No.227

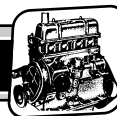

Item	Page & Issue No.	Item	Page & Issue No.
Carpet Trimming	p37 Jun 87 No.84	Tyres - Which to Chose?	p16 Feb 85 No.56, p34 May 5 No.59, p8 Jun 85 No.60.
Clear Hood Window	p46 Oct 87 No.88	Tyres Explained	p33 Feb 89 No.104, p8 Mar 89 No.105, p54 Nov 05 No.305
Cockpit Comfort	p48 Mar 88 No.93	Tyre Speed Ratings	p18 Mar 98 No.213
Cockpit Comfort (Heat Insulation)	p60 Nov 98 No.221	Tyres Review	p4 Apr 83 No.34
Dashboard Fabrication	p56 Apr 89 No.106	Wheel and Tyre Combinations	p58 Dec 02 No.270, p34 Jan 03 No.271, p54 Feb 03 No.272
Door Seal Renewal	p16 Apr 84 No.46	Wheel and Tyre Tips	p78 Jul 01 No.253, p77 Oct 01 No.256
Door Seals (Herald)	p30 Nov 04 No.293, p51 Mar 05 No.297	Wheel Colour	p14 Jun 02 No.264
Engine Valence Fitting (GT6)	p15 Feb 04 No.284	Wheel Restoration	p62 May 04 No.287
Gearbox Covers / Insulation	p8 Aug 97 No.206, p28 Oct 97 No.208, p18 Nov 97 No.209	Wheels and Tyres Plus	p64 Sep 00 No.243, p76 Oct 00 No.244, p41,74 Nov 00 No.245
Gearbox Oiling Access	p35 Dec 97 No.210	Wheel Slot Width (Spitfire)	p15 Jun 02 No.264
Headlining Replacement	p63 Dec 93 No.162	White Wall Tyres	p29 Apr 84 No.46, p14 Feb 88 No.92
Hood Fitting	p30 Jun 84 No.48, p70 Feb 01 No.248 p70 Feb 01 No.248 p68 Nov 02 No.269	Wire Wheel Adaptor Reclamation?	p31 Jun 88 No.96
Hood Fitting Tips	p47 Dec 93 No.162	Wire Wheel Conversions	p7 Sep 84 No.51
Inner Weather Strip Fitting	p30 Oct 02 No.268	Wire Wheels	p30 Nov 85 No.65
Metro Seats in a Herald/Vitesse	p18 Mar 99 No.225	Wire Wheel Splines' Greasing	p41 Sep 05 No.303
Rear Deck Security (GT6)	p43 Feb 01 No.80	Workshop Techniques:	
Rear Seats (GT6)	p28 Nov 03 No.281, p28 Dec 03 No.282, p54 Jan 04 No.283	Apollo Paint Spraying	p55 Mar 88 No.105
Rubber Bumper Repairs	p68 Oct 01 No.256	Arc Body Welders	p20 Sep 87 No.87
Scratching Hoods	p63 Nov 89 No.113	Blast Cleaning Techniques	p41 Jun 84 No.48, p59 Nov 91 No.137
Seat Rebuild (Herald)	p74 Dec 99 No.234, p61 Mar 00 No.237	Brazing and Arc Welding	p26, 45 Mar 86
Seat Renovation (Spitfire)	p70 Jul 99 No.229	No.69 Canadian Specialists	p74 Oct 05 No.304
Seat Renovation Tips	p38 Apr 98 No.214	Chrome Plating	p46 Aug 84 No.50
Seat Repair	p19 Sep 97 No.207	Chrome Plating?	p32 Apr 84 No.46
Seat Webbing Diaphragms	p79 May 98 No.215	Cold Shrinking	p37 Jul 86 No.73
Sound Deadening	p8 July 98 No.217	DIY Rear Spring Lifter	p81 Mar 90 No.117
Stick on Graphics	p74 July 99 No.229	Electroplating	p24 Jul 02 No.265
Tonneau Cover Securing	p38 Feb 88 No.92, p41 Mar 88 No.93	Eye Protection	p74 May 03 No.275
Trim Clips	p15 Aug 98 No.218	Filler Use (Metal Loaded)	p12 Jun 87 No.84
Trim Panel DIY Manufacture	p37 Apr 87 No.82	Inspection Ramps Fabrication	p56 Aug 04 No.290
Upper Bonnet Grill	p74 Feb 02 No.260	Lead Loading (on GT6's)	p33 Jun 86 No.72
Weatherstrip Substitute	p55 May 89 No.107	MIG Welding	p34 Jun 84 No.48
Wheel Trim Renovation	p15 Aug 98 No.218	Mig Welding for Beginners	p11 Apr 86 No.70, p35 May 86 No.71
Windscreen Sealing (GT6)	p30 Sep 04 No.291	Mig Welding Tips	p23 Jun 86 No.72
Windscreen Surround Fitting	p64 Sep 00 No.243	MIG Welding Update	p41 Sep 89, No.111
Windscreen Trim Tool	p61 Apr 03 No.274	New from the Trade	p76 Aug 04 No.290, p68 Oct 04 No.292
Wheels and Tyres:		Nickel Plating	p39 Dec 03 No.282
Alloy Wheel Fitting	p62 July 00 No.241	Plastic Dry Stripping	p45 Oct 91 No.136
Alloy Wheels	p47 Sep 90 No.123, p48 Apr 04 No.286, p62 May 04 No.287	Rolling Roads	p55 Nov 04 No.293
Alloy Wheel Options (Spitfire)	p10 Jun 00 No.240	Sandblaster Tip	p52 May 03 No.275
Cross-ply vs Radials	p14 Nov 97 No.209	Slide Hammer Making and Use	p36 Aug 86 No.74
Crossply Tyres - Remanufactured	p6 Jul 97 No.205	Spot Blaster Test	p69 May 89 No.107
Dolomite, Montego Wheels?	p10 Apr 00 No.238, p62 Apr 00 No.238	Spot Welder	p18 Nov 87 No.89
Herald Roadwheels	p30 Jan 00 No.235, p26 Feb 00 No.236	Veneering	p28 Jun 99 No.228
Michelin Tyres	p22 Feb 98 No.212	Ventilated Face Mask	p43 Mar 98 No.213
Tired Tyres	p8 Sep 93 No.159	Welding Tips	p74 Oct 01 No.256
Tyre Mix Problems	p63 Jul 93 No.157, p9 May 94 No.167		
Tyres	p11 Mar 91 No.129		

Technical Specifications

Whereas every care has been taken to ensure that the information given on the following pages is correct, errors may have occurred so please always refer to your workshop manual for full specifications. In addition if errors are spotted please let us know so that we may update them for future editions. Although as far as possible all figures have been taken from factory manuals, it should be noted that some quoted figures seem to vary a little depending on whether one refers to the car's handbook or workshop manual. Figures given for engine timing will also be those for the recommended fuel of the day and hence may have to be adjusted to take into account today's fuel octane ratings.

Wheel alignment figures are generally quoted as unladen or 'kerb' condition though sometimes different values are given in texts for laden conditions. Sometimes it's not made clear for what conditions the values are quoted. Here all values are assumed for unladen conditions. Early workshop manuals also appear to have confused ways of converting imperial to metric units.

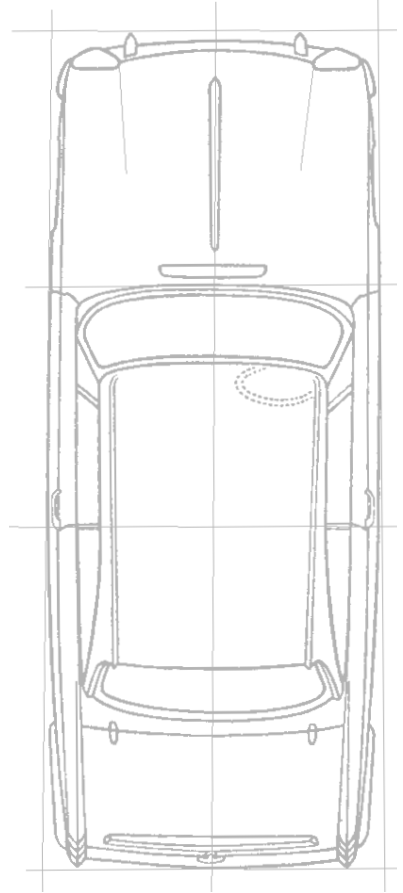
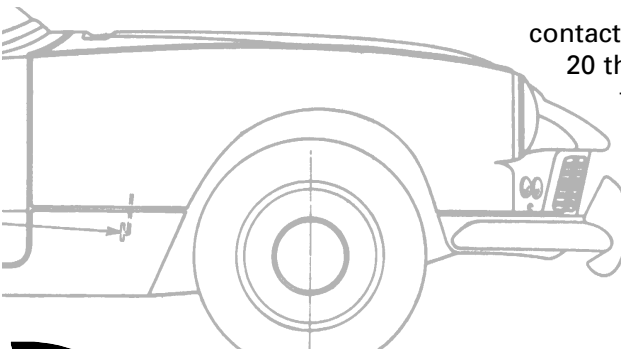

For example early Spitfire contact breaker gaps are quoted as 20 thou. but both 0.4 and 0.5mm figures are given in different manuals. Personally, I've assumed that the imperial units are correct here and like all enthusiasts I'll put down any differences as part of the interest and fun of owning an older vehicle.

Technical Specifications



Herald 948

Engine 4 cylinder, 948cc.
 Valve rocker clearances
 (set cold): Inlet and exhaust,
 0.010" or 0.25mm.
 Oil pressure: 40-60 lb/sq.in.
 @2000rpm, engine hot

Ignition System

Contact breaker gap: 0.016" or 0.4mm.
 Spark plugs and gap: Lodge CLN-H, HLN
 0.025" or 0.64mm.
 Firing order: 1, 3, 4, 2.
 Ignition timing (static): 10° BTDC Single
 Carb (8:1 CR).
 10° BTDC Twin Carb
 (7.9:1 CR).
 12° BTDC Twin Carb
 (8.5:1 CR).

Brakes, Steering and Tyres

Front wheels: 8" x 1.25" drum, twin
 leading shoe.
 Rear wheels: 7" x 1.25" drum,
 leading & trailing shoe
 Tyre pressures (Saloon): Front 19psi. Rear 24psi
 (26psi. 4-up).
 Tyre pressures (Coupé): Front 19psi. Rear 24psi
 Tyre size: 5.20-13.
 Wheel alignment front: 0-1/16" (0-1.6mm) toe-in
 Wheel alignment rear: 0-1/16" (0-1.6mm) toe-in
 Steering Rack: 3 3/8 turns lock to lock

Capacities

Fuel tank: 6.25 gallons, 32 litres
 Engine oil (drain and refill): 7 pints, 4 litres
 Gearbox: 1.5 pints, 0.85 litres
 Rear axle: 1 pint, 0.57 litres
 Cooling system: 8.5 pints, 39 litres

Herald 1200 & 12/50

As 948 except:

Engine 1147cc.

Ignition System

Contact breaker gap: 0.015" or 0.38mm
 Spark plugs and gap: Lodge CLNY, CNY up
 to GA185794E and
 GD65575E then
 Champion L87Y later
 0.025" or 0.64mm
 Ignition timing (static): 15° BTDC.

Brakes, Steering and Tyres

Front wheels: 8" x 1.25" drum
 twin leading shoe.
 9" disc optional on 1200
 9" disc standard 12/50

..... Tyre pressures (Saloon,
 Coupé and Convertible): Front 21psi. Rear 24psi
 (28psi 4-up).
 Tyre pressures (Estate): Front 21psi. Rear 25psi
 (30psi 4-up).
 Tyre pressures (Courier Van): Front 15psi. Rear 25psi
 (32psi fully laden).
 Tyre size (Saloon, Coupé
 and Convertible): 5.20-13.
 Tyre size
 (Estate and Courier Van): 5.60-13.

Capacities

Fuel tank
 (Estate and Courier Van): 9 gallons, 41 litres.

Herald 13/60

As 1200 and 12/50 except:

Engine 1296cc.

Ignition System

Spark plugs: Champion N-9Y.
 Ignition timing (static): 9° BTDC.

Brakes, Steering and Tyres

Front wheels: 9" disc brake standard

Vitesse 6

Engine 6 cylinder, 1596cc.

Valve rocker clearances
 (set cold): Inlet and exhaust,
 0.010" or 0.25mm.
 Oil pressure: 40-60 lb/sq.in.
 @2000rpm, engine hot

Ignition System

Contact breaker gap: 0.015" or 0.38mm.
 Spark plugs: Lodge CLNY up to
 eng. no. HB28207E
 Lodge L87Y after.
 Spark plug gap: 0.025" or 0.64mm.
 Firing order: 1, 5, 3, 6, 2, 4.
 Ignition timing (static): 10° (BTDC).

Brakes, Steering and Tyres

Front wheels: 9" disc brakes.
 Rear wheels: 8" x 1.25" drum,
 leading & trailing shoe
 Steering Rack: 3 3/4 turns lock to lock.
 Tyre pressures: Front 22psi. Rear 24psi
 (26psi. 4-up).
 Tyre size: 5.60-13in.
 Wheel alignment front: 0-1/16" (0-1.6mm) toe-in
 Wheel alignment rear: 0-1/16" (0-1.6mm) toe-in

Capacities

Fuel tank: 8.75 gallons, 39.4 ltrs.

Technical Specifications



Spitfire Mk IV

As Spitfire Mk.3 except:

Ignition System

Ignition timing (static):.....8° BTDC from FH25000

Brakes, Steering and Tyres

Tyre pressures:Front 21 psi. Rear 26 psi.

Tyre sizes:145SR-13.

Wheel alignment rear: $\frac{1}{32}'' - \frac{3}{32}''$
(0.8mm-2.4mm) toe-out.

Capacities

Fuel:7.25 gallons,
33 litres from FH60000.

Gearbox with overdrive:2.7 pints, 1.5 litres.

Spitfire 1500

As Spitfire Mk.IV except:

Engine1493cc.

Brakes, Steering and Tyres

Tyre pressures:Front 21psi. Rear 26psi

Tyre sizes:155SR-13.

Ignition System

Spark plugs:Champion N-12Y
from FM33738.

Ignition timing: (static):10° BTDC.

GT6 Mk I

Engine6 cylinder, 1998cc.

Valve rocker clearances
(set cold): Inlet and exhaust0.010" or 0.25mm.

Oil pressure:40-60 lb/sq.in.
@2000rpm, engine hot.

Ignition System

Contact breaker gap:0.015" or 0.38mm.

Spark plugs and gap:.....Champion N-9Y,
0.025" or 0.64mm.

Firing order:1, 5, 3, 6, 2, 4.

Ignition timing (static):.....13° before top dead
centre (BTDC) 5-star
fuel. For 4-star fuel
reduce to ~7°BTDC.

Brakes, Steering and Tyres

Front wheels:9.7" disc.

Rear wheels:8" x1.25" drum, leading
and trailing shoe.

Tyre pressures:Front 20psi. Rear 24psi.

Tyre size:155-13.

Wheel alignment front: $\frac{1}{16}'' - \frac{1}{8}''$
(1.6mm-3.2mm) toe-in.

Wheel alignment rear: $\frac{1}{16}'' - \frac{1}{8}''$
(1.6mm-3.2mm) toe-out

Steering Rack:.....4 $\frac{1}{4}$ turns lock to lock.

Capacities

Fuel tank:9.75 gallons, 44.3 litres

Engine oil:8 pints, 4.5 litres.

Gearbox:1.5 pints, 0.85 litres.

.....2.38 pints, 1.35 litres
with overdrive.

Rear axle:1 pint, 0.57 litres.

Cooling system:11 pints, 6.2 litres.

GT6 Mk II & '+'

As GT6 Mk.1 except:

Ignition System

Spark plugs(emission controlled '+ ' only):

Champion UN-12Y.

Ignition timing (static):.....10° BTDC Mk.2 and '+'

Brakes, Steering and Tyres

Tyre pressures ('+' G800):Front 24psi. Rear 30psi

Tyre pressures

(1972 1 or 2 up SP68):Front 24psi. Rear 28psi

Tyre pressures

(1972 fully laden SP68):Front 24psi. Rear 34psi

Wheel alignment rear:0 $\pm \frac{1}{32}''$ (± 0.8 mm).

GT6 Mk III

As GT6 Mk.2 and '+ ' except:

Ignition System

Spark plugs (emission controlled USA spec. only):

Champion UN-12Y.

Ignition timing (static):.....6° BTDC Mk.3. 12° BTDC
(USA spec. Mk.3).

Brakes, Steering and Tyres

Rear wheels:8" x1.5" drum, leading
& trailing shoe

Tyre pressures (Pre 1973):As Mk.2.

Tyre pressures (1973):Front 30psi. Rear 26psi

STAG

Engine8 cylinder, 2997cc

Valve rocker clearancesInlet 0.008-0.01"
(0.2-0.25mm)

Exhaust 0.016-0.018"
(0.41-0.46mm).....



Technical Specifications

STAG Contd.

Ignition System

Contact breaker gap:0.015" (0.4mm)
 Spark plugs and gap:.....Champion N-11Y
 (or N-12Y particularly for Australian market regarding
 emission requirements)
0.025" (0.64mm)
 Firing order:1, 2, 7, 8, 4, 5, 6, 3
 (No.1 front, right bank odd, left bank even)
 Ignition timing (static):.....14° BTDC up to
engine no. LF20,000
12° BTDC from
LF20,001 on

Brakes, Steering and Tyres

Front brakes:.....10.625" discs
 Rear brakes:9" x 2.25" drum
 Tyre size:175-HR14 or 185-HR14
 Tyre pressures:Front 26psi. Rear 30psi
 Wheel alignment front: $\frac{1}{16}$ " - $\frac{1}{8}$ "
 (1.5 - 3.0mm) toe-in
 Wheel alignment rear:0 - $\frac{1}{16}$ "
 (0 - 1.5mm) toe-in
 Steering rack:Pre 1972 4 turns
 lock to lock
 1972-73 3 turns
 lock to lock
 1974 on 2.5 turns
 lock to lock

Capacities

Fuel tank:.....12.75 gallons, 58 litres
 Engine oil (drain and refill):.....8 pints, 4.5 litres
 Gearbox:3.5 pints, 2 litres
 incl. overdrive
 Rear axle:2 pints, 1.1 litres
 Cooling system:18.5 pints, 10.5 litres

1300

Engine4 cylinder, 1296cc
 Valve rocker clearancesInlet and exhaust,
 0.010" (0.25mm)
 Oil pressure:40-60psi @ 2000rpm

Ignition System

Contact breaker gap:0.015" (0.4mm)
 Spark plugs and gap:.....Champion N-9Y
 0.025" (0.64mm)
 Firing order:1, 3, 4, 2
 Ignition timing (static):.....9° BTDC
 (6° BTDC, TC model)

Brakes, Steering and Tyres

Front brakes:.....8.75" disc
 Rear brakes:8" x 1.25" drum
 Tyre size:5.60-13
 Tyre pressures:Front 22psi. Rear 22psi
 Wheel alignment front:0 - $\frac{1}{16}$ "
 (0 - 1.6mm) toe-out

Wheel alignment rear:0 - $\frac{1}{16}$ "
 (0 - 1.6mm) toe-out
 Steering rack:Rack and pinion.
 3.25 turns lock to lock

Capacities

Fuel tank:.....11.75 gallons, 53.4 litres
 Engine oil (drain and refill):.....6.25 pints, 3.5 litres
 Gearbox:2.25 pints, 1.3 litres
 Final drive:1.25 pints, 0.7 litres
 Cooling system:6.25 pints,
 3.5 litres (with heater)

1500

As 1300 except:

Engine4 cylinder, 1493cc

Ignition System

Ignition timing (static):.....10° BTDC

Brakes, Steering and Tyres

Rear brakes:8" x 1.5" drum
 Tyre size:5.60-13, 155-SR13
 Tyre pressures:Front 26psi. Rear 26psi
 Wheel alignment front:0 - $\frac{1}{16}$ "
 (0 - 1.6mm) toe-out
 Wheel alignment rear:
 Steering rack:3 turns lock to lock

Capacities

Fuel tank:.....2.5 gallons, 57 litres
 Cooling system:8.5 pints,
 4.8 litres (with heater)

TOLEDO

Engine4 cylinder, 1296cc
 Valve rocker clearancesInlet and exhaust,
 (set cold): 0.01" (0.25mm)
 Oil pressure:40-60psi @ 2000rpm

Ignition System

Contact breaker gap:0.015" (0.4mm)
 Spark plugs and gap:.....Champion N-9Y
 0.025" (0.64mm)
 Firing order:1, 3, 4, 2
 Ignition timing (static):.....9° BTDC

Brakes, Steering and Tyres

Front brakes:.....9" x 1.75" drum
 8.75" disc 4 door
 Rear brakes:8" x 1.5" drum
 Tyre size:5.20 -13, 155 SR13
 Tyre pressures:Front 25 psi. Rear 30psi

Capacities

Fuel tank:.....10.5 gallons, 47.7 litres
 Engine oil (drain and refill):.....7.5 pints, 4.3 litres
 Gearbox:1.4 pints, 0.8 litres

Technical Specifications



Rear axle:1.5 pints, 0.8 litres
Cooling system:8.5 pints
incl. heater, 4.8 litres

DOLOMITE 1300

Engine4 cylinder, 1296cc
Valve rocker clearancesInlet and exhaust,
(set cold): 0.01" (0.25mm)
Oil pressure:40-60psi @ 2000rpm

Ignition System

Contact breaker gap:0.015" (0.4mm)
Spark plugs and gap:N-12Y
0.025" (0.64mm)
Firing order:1, 3, 4, 2
Ignition timing (static):10° BTDC

Brakes, Steering and Tyres

Front brakes:8.75" disc
Rear brakes:8" x 1.5" drum
Tyre size:155 SR 13
Tyre pressures:Front 22psi.
Rear 26psi

Capacities

Fuel tank:12.5 gallons, 56.8 litres
Engine oil (drain and refill):7.5 pints, 4.3 litres
Gearbox:1.5 pints, 0.8 litres
Rear axle:1.5 pints, 0.8 litres
Cooling system:8.5 pints,
4.8 litres incl. heater

DOLOMITE 1500

As Dolomite 1300 except:

Engine4 cylinder, 1493 cc
Brakes, Steering and Tyres
Wheel alignment front:0-1/16" (0-1.6mm) toe-in

Capacities

Engine oil (drain and refill):7.25 pints, 4.1 litres
Gearbox:1.4 pints, 0.8 litres
Rear axle:1.5 pints, 0.8 litres

DOLOMITE 1850

As Dolomite 1300 / 1500 except:

Engine4 cylinder, 1854cc

Ignition System

Spark plugs and gap:Champion N-11Y
Ignition timing (static):11° BTDC

Brakes, Steering and Tyres

Tyre pressures:Front 26psi. Rear 30psi

Capacities

Engine oil (drain and refill):8 pints, 4.5 litres
Gearbox:1.8 pints, 1 litre (2.9pints,

1.7 litres with overdrive)
Automatic:11.5 pints,
6.5 litres incl. oil cooler
Cooling system:9.5 pints, 5.4 litres

DOLOMITE SPRINT

Engine4 cylinder, 1998 cc
Valve rocker clearancesInlet and exhaust
(set cold): 0.01" (0.25mm)

Ignition System

Contact breaker gap:0.015" (0.4mm)
Spark plugs and gap:Champion BN-7Y
then BN-9Y from engine
number VA18573
0.025" (0.64mm)
Firing order:1, 3, 4, 2
Ignition timing (static):10° BTDC

Brakes, Steering and Tyres

Front brakes:8.75" disc
Rear brakes:9" x 1.75" drum
Tyre size:175/70 HR 13
Tyre pressures:Front 22psi. Rear 24psi
Wheel alignment front:0-1/16" toe in
Steering rack:Rack and pinion,
3.75 turns lock to lock

Capacities

Fuel tank:12.5 gallons, 56.8 litres
Engine oil (drain and refill):8 pints, 4.5 litres
Gearbox:2 pints, 1.1 litres
(3 pints, 1.7 litres
with overdrive)
Automatic:11.5 pints,
6.5 litres incl. oil cooler
Rear axle:2 pints, 1.1 litres
Cooling system:9.5 pints, 5.4 litres

TR2

Engine4 cylinder, 1991cc
Valve rocker clearanceInlet 0.01" (0.25mm)
(set cold):
Exhaust0.012" (0.30mm)
Oil pressure:65-75psi @ 2000rpm

Ignition System

Contact breaker gap:0.015" (0.4mm)
Spark plugs and gap:Champion L10S
0.032" (0.8mm)
Firing order:1, 3, 4, 2
Ignition timing (static):4° BTDC

Brakes, Steering and Tyres

Front brakes:10" x 2.25" drum
Rear brakes:9" x 1.75" drum
10" x 2.25" all round from Autumn 1954,
Comm.No.TS5481



Technical Specifications

TR2 Continued

Tyre size: 5.50-15
 Tyre pressures: Front 22psi, Rear 24psi
 Steering rack: Cam and Lever.
 2.33 turns lock to lock

Capacities

Fuel tank: 12.5 gallons, 56.8 litres
 Engine oil (drain and refill): 10 pints, 5.7 litres
 Gearbox: 5 pints, 0.8 litres
 (2.75 pints, 1.6 litres with overdrive)
 Rear axle: 1.5 pints, 0.8 litres
 Cooling system: 13 pints, 7.4 litres
 (14 pints, 8 litres with heater)

TR3

As given for TR2 except:

Ignition System

Spark plugs: Champion L87Y

Brakes, Steering and Tyres

Front brakes: 11" disc fitted from
 Comm.No. TS13046
 Wheel alignment front: 0 - 1/8" (0- 3.2mm) toe-in

TR3A

As given for TR3 except:

Engine 2138cc option from 1959

Brakes, Steering and Tyres

Rear brakes: 9" x 1.75" drum from
 Comm.No. TS56377

TR4

Engine 4 cylinder, 2138cc
 1991cc to special order
 Valve rocker clearance Inlet and exhaust,
 (set cold): 0.01" (0.25mm)
 Oil pressure: 65-75psi @ 2000rpm

Ignition System

Contact breaker gap: 0.015" or 0.4mm
 Spark plugs and gap: Lodge CNY
 0.025" (0.64mm)
 Firing order: 1, 3, 4, 2
 Ignition timing (static): 4° BTDC

Brakes, Steering and Tyres

Front brakes: 11" disc
 Rear brakes: 9" x 1.75" drum
 Tyre size: 5.50-15 / 5.90-15
 Tyre pressures: Front 20psi, Rear 24psi
 Tyre size: 165-15

Tyre pressures: Front 24psi, Rear 28psi
 Wheel alignment front: 0 - 1/16" (0 - 1.6mm) toe-in
 Or 0-1/8" (0- 3.2mm)
 toe-in (depending on

tyres fitted)
 Steering rack: Rack and pinion

Capacities

Fuel tank: 11.75 gallons, 53.5 litres
 Engine oil (drain and refill): 10 pints, 5.7 litres
 Gearbox: 1.5 pints, 0.8 litres
 (2.75 pints, 1.6 litres with overdrive)
 Rear axle: 1.5 pints, 0.8 litres
 Cooling system: 13 pints, 7.4 litres
 (14 pints, 8 litres with heater)

TR4A

As given for TR4 except:

Ignition System

Spark plugs and gap: Champion L87Y

Brakes, Steering and Tyres

Tyre size: 5.90-15
 Tyre pressures: IRS: Front 17psi,
 Rear 21psi
 Live Axle: Front 19psi,
 Rear 23psi
 Tyre size: 165-15
 Tyre pressures: Front 24psi, Rear 28psi
 Wheel alignment front: 0 - 1/16" (0 - 1.6mm) toe-in

Capacities

Cooling system: 11 pints, 6.2 litres
 (with heater)

TR5

Engine 6 cylinder, 2498cc
 Valve rocker clearances Inlet and exhaust,
 (set cold): 0.01" (0.25mm)
 Oil Pressure 45-65psi @ 2000rpm

Ignition System

Contact breaker gap: 0.015" (0.4mm)
 Spark plugs and gap: Champion N-9Y
 0.025" (0.64mm)
 Firing order: 1, 5, 3, 6, 2, 4
 Ignition timing (static): 11° BTDC

Brakes, Steering and Tyres

Front brakes: 10.875" disc
 Rear brakes: 9" x 1.75" drum
 Tyre pressures: Front 22psi. Rear 26psi
 Tyre size: 165-HR15
 Wheel alignment front: 0 - 1/16" (0 - 1.6mm) toe-in
 Wheel alignment rear: 0 - 1/16" (0 - 1.6mm) toe-in
 Steering rack: Rack and pinion.
 3.25 turns lock to lock

Capacities

Fuel tank: 11.25 gallons, 51 litres

Technical Specifications



TR3A

As given for TR3 except:

Engine2138cc option from 1959

Brakes, Steering and Tyres

Rear brakes:9" x 1.75" drum from
Comm.No. TS56377

TR4

Engine4 cylinder, 2138cc
1991cc to special order
Valve rocker clearanceInlet and exhaust,
.....(set cold):0.01" (0.25mm)
Oil pressure:65-75psi @ 2000rpm

Ignition System

Contact breaker gap:0.015" or 0.4mm
Spark plugs and gap:Lodge CNY
.....0.025" (0.64mm)
Firing order:1, 3, 4, 2
Ignition timing (static):4° BTDC

Brakes, Steering and Tyres

Front brakes:11" disc
Rear brakes:9" x 1.75" drum
Tyre size:5.50-15 / 5.90-15
Tyre pressures:Front 20psi, Rear 24psi
Tyre size:165-15
Tyre pressures:Front 24psi, Rear 28psi
Wheel alignment front:0 - 1/16" (0 - 1.6mm) toe-in
Or 0-1/8" (0- 3.2mm)
toe-in (depending on

tyres fitted)

Steering rack: Rack and pinion

Capacities

Fuel tank:11.75 gallons, 53.5 litres
Engine oil (drain and refill):10 pints, 5.7 litres
Gearbox:1.5 pints, 0.8 litres
(2.75 pints, 1.6 litres
with overdrive)
Rear axle:1.5 pints, 0.8 litres
Cooling system:13 pints, 7.4 litres
(14 pints, 8 litres
with heater)

TR4A

As given for TR4 except:

Ignition System

Spark plugs and gap:Champion L87Y

Brakes, Steering and Tyres

Tyre size:5.90-15
Tyre pressures:IRS: Front 17psi,
Rear 21psi
Live Axle: Front 19psi,

Rear 23psi

• Tyre size:165-15
• Tyre pressures:Front 24psi, Rear 28psi
• Wheel alignment front:0 - 1/16" (0 - 1.6mm) toe-
in

Capacities

• Cooling system:11 pints, 6.2 litres
.....(with heater)

TR5

• **Engine**6 cylinder, 2498cc
• Valve rocker clearancesInlet and exhaust,
.....(set cold):0.01" (0.25mm)
• Oil Pressure45-65psi @ 2000rpm

Ignition System

• Contact breaker gap:0.015" (0.4mm)
• Spark plugs and gap:Champion N-9Y
.....0.025" (0.64mm)
• Firing order:1, 5, 3, 6, 2, 4
• Ignition timing (static):11° BTDC

Brakes, Steering and Tyres

• Front brakes:10.875" disc
• Rear brakes:9" x 1.75" drum
• Tyre pressures:Front 22psi, Rear 26psi
• Tyre size:165-HR15
• Wheel alignment front:0 - 1/16" (0 - 1.6mm) toe-
in
• Wheel alignment rear:0 - 1/16" (0 - 1.6mm) toe-
in
• Steering rack:Rack and pinion.

2000

• **Engine**6 cylinder, 1998cc
• Valve rocker clearancesInlet and exhaust,
(set cold):
0.01" (0.25mm)
• Oil pressure:40-60psi
@ 2000rpm

Ignition System

• Contact breaker gap:0.015" (0.4mm)
• Spark plugs and gap:Champion N-12Y
or N-9Y
0.025" (0.64mm)
• Firing order:1, 5, 3, 6, 2, 4
• Ignition timing (static):10° BTDC
(8° BTDC Mk.2)

(different reference guides appear to have these the
other way around)

Brakes, Steering and Tyres

• Front brakes:9.75" disc
• Rear brakes:9" x 1.75" drum
• Tyre pressures:Front 26psi, Rear 26psi
• Tyre size:175- SR13
• Wheel alignment front:0-1/16" (0-1.6 mm) toe-in
• Wheel alignment rear:0-1/16" (0-1.6mm) toe-in

Technical Specifications



2000 Contd.

Capacities

Fuel tank:14 gallons, 63.6 litres
Engine oil (drain and refill):8 pints, 4.5 litres
Gearbox:2.5 pints, 1.4 litres
(3.6 pints, 2 litres
with J Type overdrive,
4.3 litres A-Type)
Auto transmission12.5 pints,
7.1 litres (with oil cooler)
Rear axle:2 pints, 1.1 litres
Cooling system:13.5 pints,
7.6 litres (incl. heater)

2000 TC

As given for 2000 except:

Engine6 cylinder, 2498cc

Ignition system

Ignition timing (static):10° BTDC

Brakes, Steering and Tyres

Tyre size:185- HR13

2500 S

As 2500TC except:

Brakes, Steering and Tyres

Tyre size:175 HR14

• Tyre pressures (Saloon):Front 26psi. Rear 26psi
• Tyre pressures (Estate):Front 26psi. Rear 34psi
• Cooling system:9.5 pints, 5.4 litres

Capacities

Fuel tank (Estate):12.75 gallons, 57.9 litres

2.5 PI

As given for 2500TC except:

Ignition System

• Spark plugs and gap:Champion N-9Y
• Timing:8° BTDC (2° BTDC for
post 1973 cars?)

Brakes, Steering and Tyres

• Tyre size:185 SR13
• Tyre pressures (Saloon):Front 26psi. Rear 30psi

Capacities

• Fuel tank (Estate):14 gallons, 8 litres
• Gearbox;2.5 pints, 1.4 litres
(4.3 pints, 2.5 litres
with overdrive)
• Rear axle:1.75 pints, 1 litre

Notes